

# BESSERHAUS

PVC KAPI VE PENCERE SİSTEMLERİ



ÜRÜN KATALOĞU  
PRODUCT CATALOG  
ПРОДУКТЫ КАТАЛОГ

كتالوج المنتجات

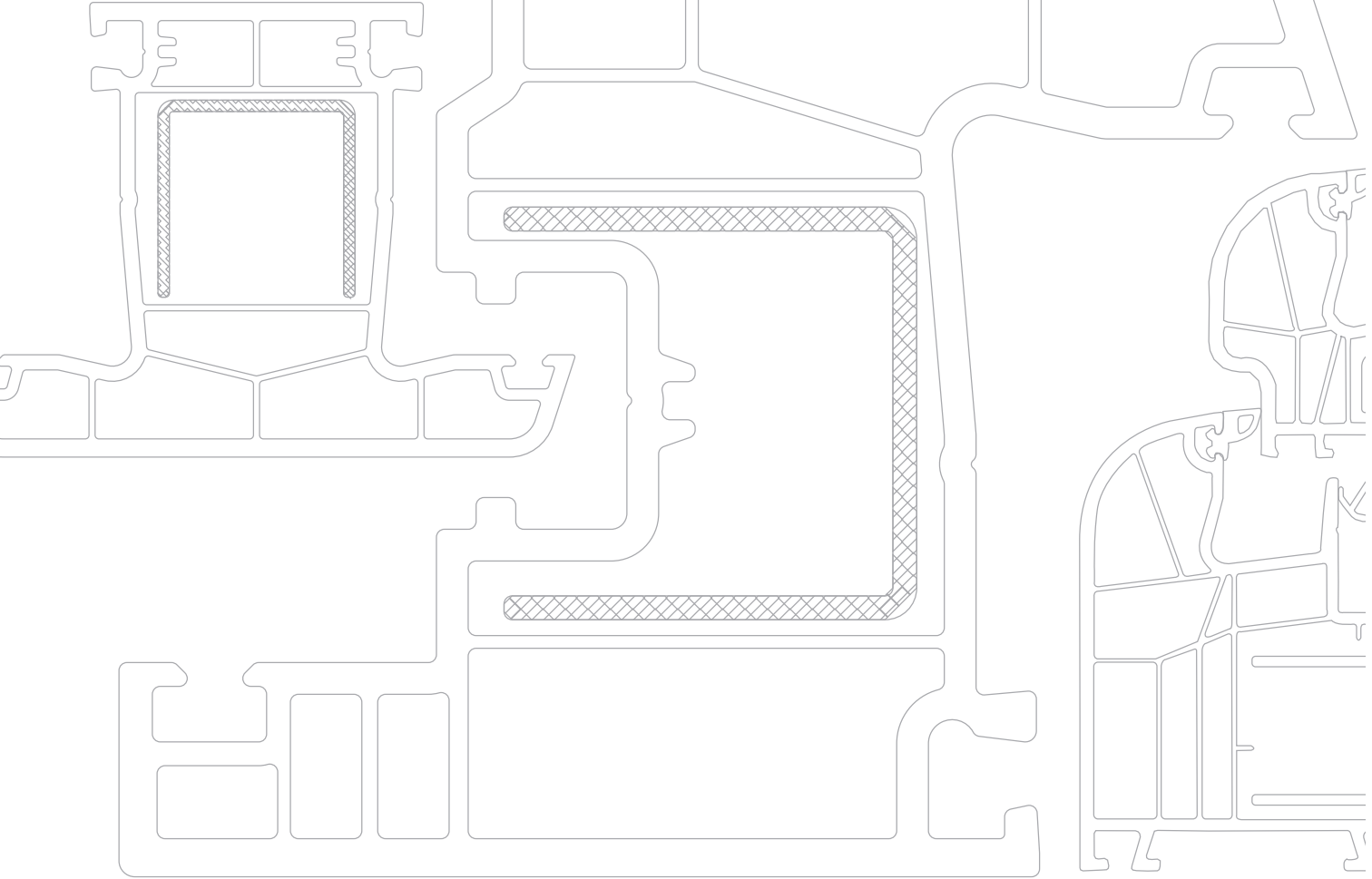

NEHIR

SERISI

# BESSERHAUS

PVC DOOR AND WINDOWS SYSTEM

## GR 602101

Kasa Profili	Ağırlık : 980gr/m.
Frame	Weight : 980gr/m.
Pama	Bec : 980gr/m.
بروفيل الاطار	الوزن : ٩٢٠ غام

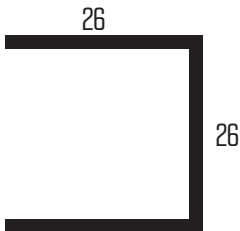
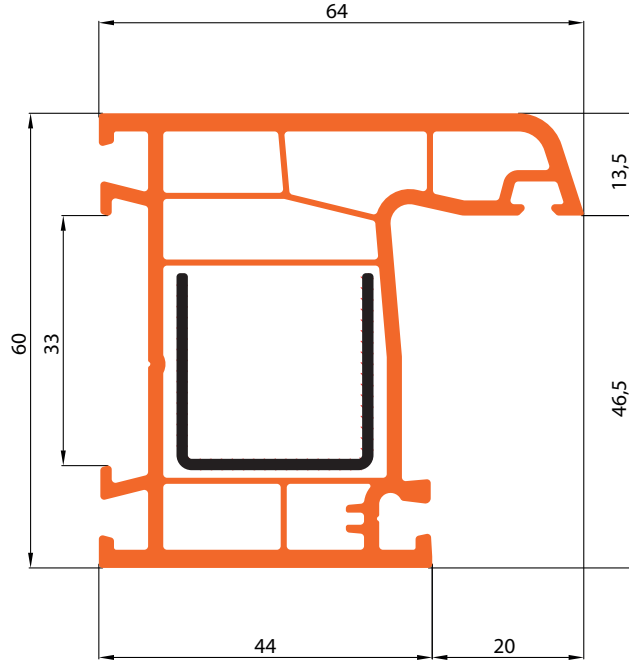
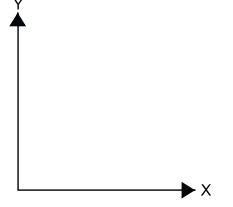

S= 1.20 mm	692 gr/mt	Ix= 1,005 cm <sup>4</sup>	Iy= 0,613 cm <sup>4</sup>
S= 1.50 mm	866 gr/mt	Ix= 1,295 cm <sup>4</sup>	Iy= 0,780 cm <sup>4</sup>
S= 2.00 mm	1.155 gr/mt	Ix= 1,824 cm <sup>4</sup>	Iy= 1,092 cm <sup>4</sup>

# BESSERHAUS

PVC DOOR AND WINDOWS SYSTEM

## GR 602102

Kanat Profil	Ağırlık	: 1128 gr/m.
Sash	Weight	: 1128 gr/m.
створка	Вес	: 1128 gr/m.
بروفيل الضلفة	الوزن	: ١١٥٠ غم

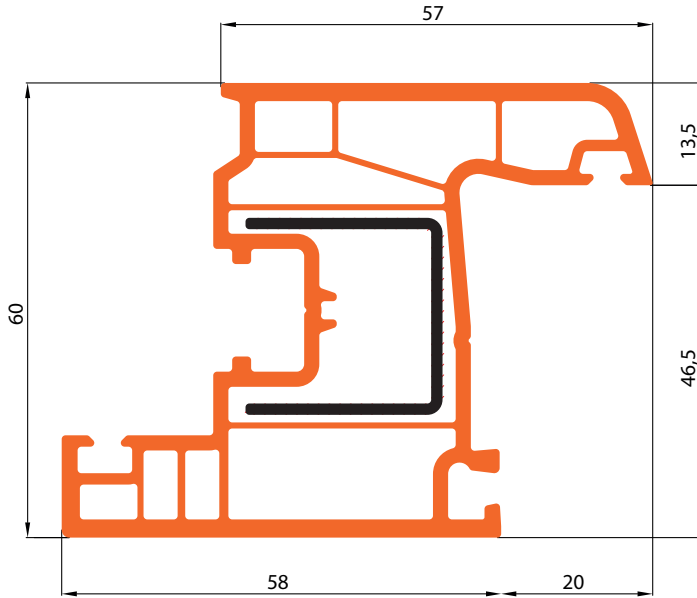
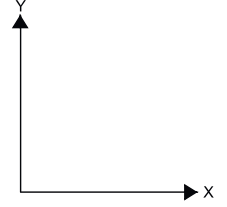

4

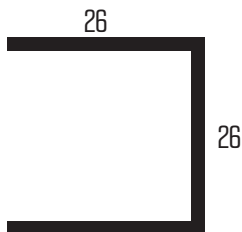

S= 1.20 mm	692 gr/mt	Ix= 1,005 cm <sup>4</sup>	Iy= 0,613 cm <sup>4</sup>
S= 1.50 mm	866 gr/mt	Ix= 1,295 cm <sup>4</sup>	Iy= 0,780 cm <sup>4</sup>
S= 2.00 mm	1.155 gr/mt	Ix= 1,824 cm <sup>4</sup>	Iy= 1,092 cm <sup>4</sup>

## GR 602103

Ortakayıt Profili

Mullion

Импост

بروفیل تي

Ağırlık : 1111 gr/m.

Weight : 1111 gr/m.

Вес : 1111 gr/m.

الوزن : 1111 غم

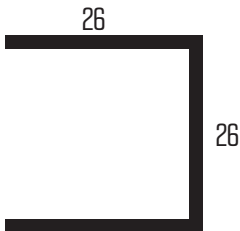
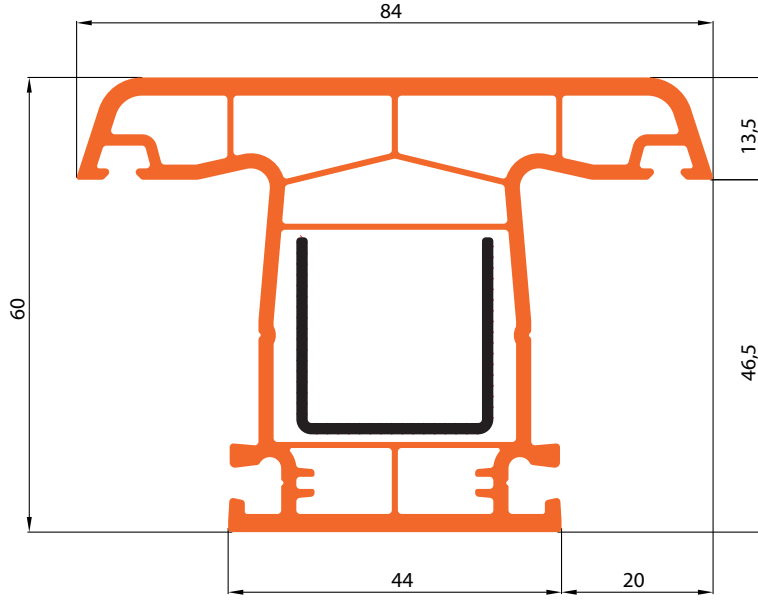
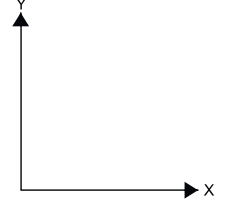

S= 1.20 mm    692 gr/mt    I<sub>x</sub>= 1,005 cm<sup>4</sup>    I<sub>y</sub>= 0,613 cm<sup>4</sup>

S= 1.50 mm    866 gr/mt    I<sub>x</sub>= 1,295 cm<sup>4</sup>    I<sub>y</sub>= 0,780 cm<sup>4</sup>

S= 2.00 mm    1.155 gr/mt    I<sub>x</sub>= 1,824 cm<sup>4</sup>    I<sub>y</sub>= 1,092 cm<sup>4</sup>

# BESSERHAUS

PVC DOOR AND WINDOWS SYSTEM

Pervazlı Kasa Profili  
Frame With Cornice Profile  
Рама с откосом  
بروفیل الاطار بکشف

Ağırlık : 1218 gr/m.  
Weight : 1218 gr/m.  
Bec : 1218 gr/m.  
الوزن : ۱۲۰۰ غام

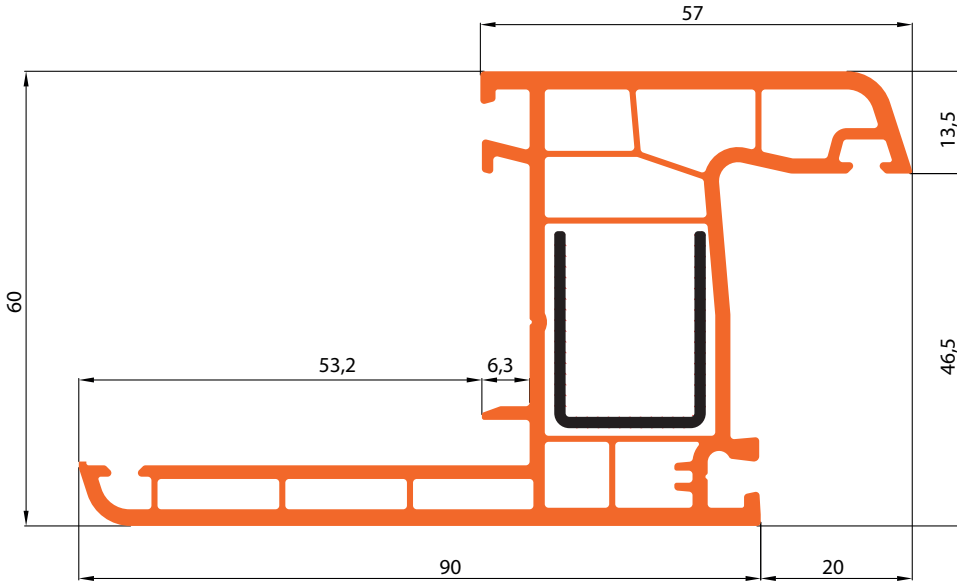
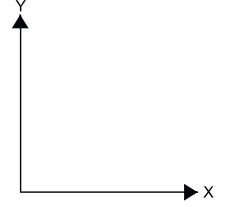

6

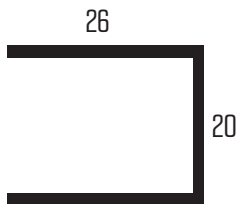

S= 1.20 mm	636 gr/mt	$I_x = 0,549 \text{ cm}^4$	$I_y = 0,556 \text{ cm}^4$
S= 1.50 mm	796 gr/mt	$I_x = 0,713 \text{ cm}^4$	$I_y = 0,707 \text{ cm}^4$
S= 2.00 mm	1.060 gr/mt	$I_x = 1,019 \text{ cm}^4$	$I_y = 0,992 \text{ cm}^4$

## GR 602105

İçe Açılır Kapı Kanat Profili

In turn Door Sash Profile

дверная створка открытие вовнутрь

بروفيل ضلفة الباب الفته الى الداخل

Ağırlık : 1378 gr/m.

Weight : 1378 gr/m.

Bec : 1378 gr/m.

الوزن : ١٣٧٨ غم

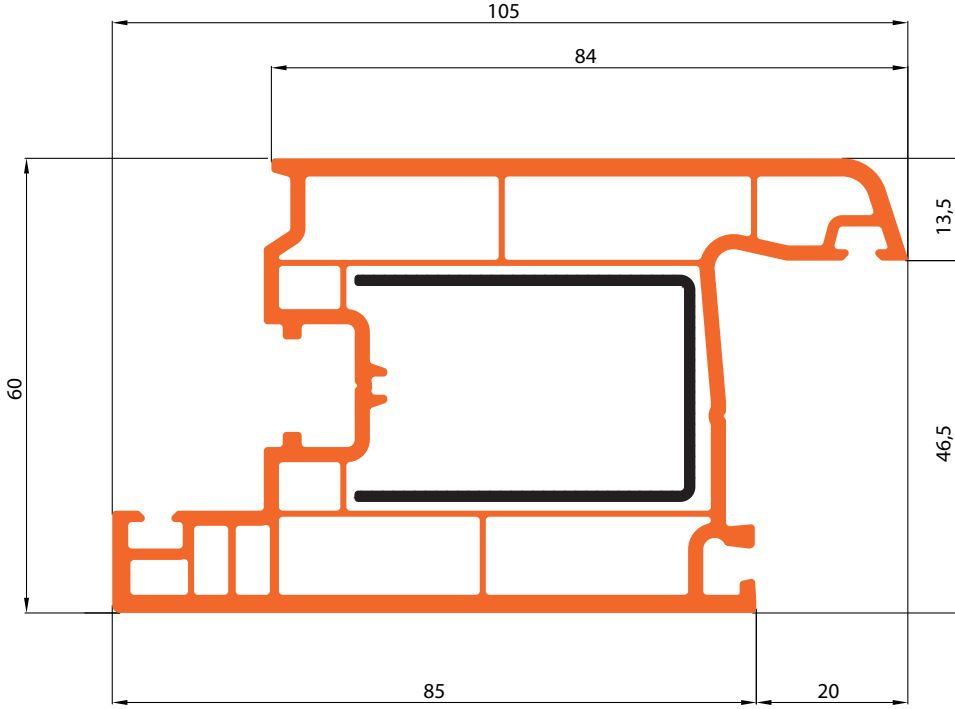
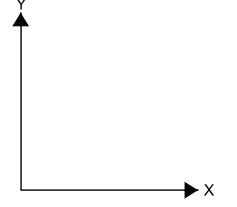

S= 1.20 mm 1.067 gr/mt  $I_x= 2,919 \text{ cm}^4$   $I_y= 2,304 \text{ cm}^4$

S= 1.50 mm 1.533 gr/mt  $I_x= 3,689 \text{ cm}^4$   $I_y= 2,951 \text{ cm}^4$

S= 2.00 mm 1.778 gr/mt  $I_x= 5,062 \text{ cm}^4$   $I_y= 4,110 \text{ cm}^4$

# BESSERHAUS

PVC DOOR AND WINDOWS SYSTEM

## GR 602106

DıŖa Açılır Kapı Kanat Profili  
Out Turn Door Sash Profile

дверная створка открытие наружу  
بروفیل ضلفة الباب الفته الى الخارج

Ađırlık : 1378 gr/m.  
Weight : 1378 gr/m.  
Вес : 1378 gr/m.  
الوزن : ١٣٧٨

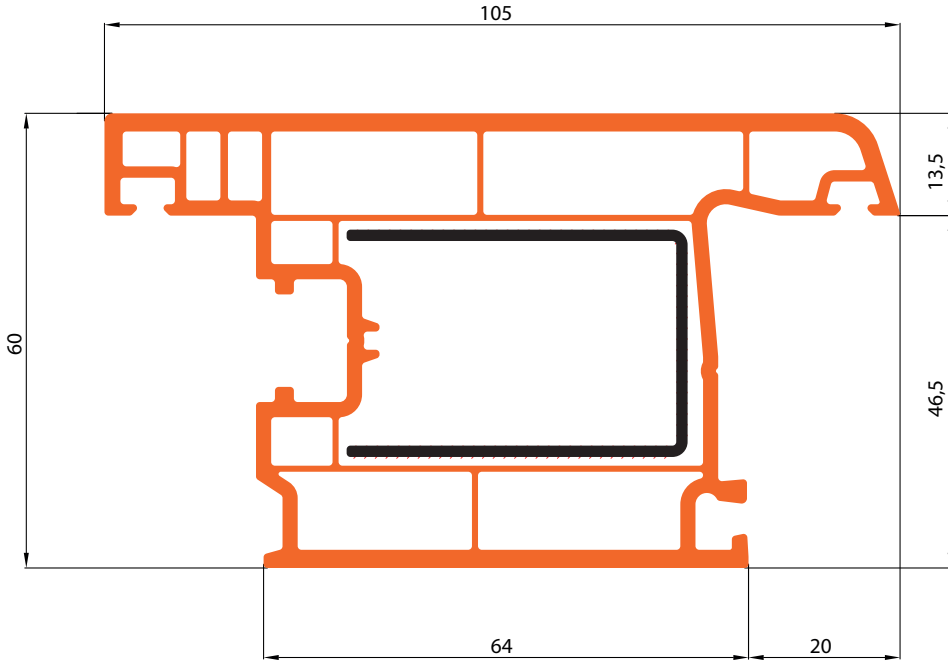
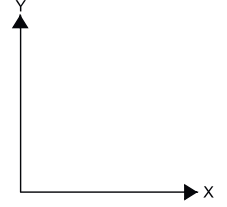

8

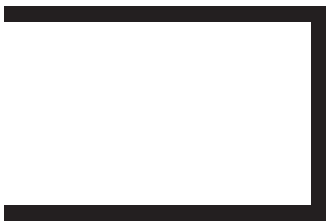

45

30

S= 1.20 mm	1.067 gr/mt	I <sub>x</sub> = 2,919 cm <sup>4</sup>	I <sub>y</sub> = 2,304 cm <sup>4</sup>
S= 1.50 mm	1.533 gr/mt	I <sub>x</sub> = 3,689 cm <sup>4</sup>	I <sub>y</sub> = 2,951 cm <sup>4</sup>
S= 2.00 mm	1.778 gr/mt	I <sub>x</sub> = 5,062 cm <sup>4</sup>	I <sub>y</sub> = 4,110 cm <sup>4</sup>



**Dıęa Açılır Kanat Profili**  
**Out Turn Sash Profile**

створка открытие наружу  
بروفيل ضلفة الفتحة الى الخارج

Ağırlık : 1204 gr/m.  
Weight : 1204 gr/m.  
Вес : 1204 gr/m.  
الوزن : ١٢٠٤ غام

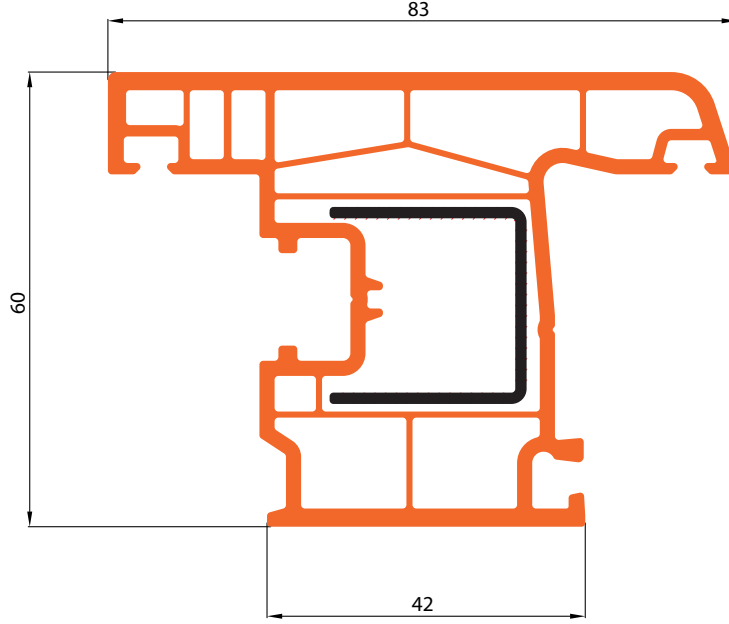
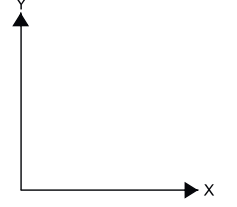

26

S= 1.20 mm	692 gr/mt	I <sub>x</sub> = 1,005 cm <sup>4</sup>	I <sub>y</sub> = 0,613 cm <sup>4</sup>
S= 1.50 mm	866 gr/mt	I <sub>x</sub> = 1,295 cm <sup>4</sup>	I <sub>y</sub> = 0,780 cm <sup>4</sup>
S= 2.00 mm	1.155 gr/mt	I <sub>x</sub> = 1,824 cm <sup>4</sup>	I <sub>y</sub> = 1,092 cm <sup>4</sup>

# BESSERHAUS

PVC DOOR AND WINDOWS SYSTEM

20 mm Çift Cam Çıtası      Ağırılık : 178 gr/m.  
Double Glazing Bead For 20mm      Weight : 178 gr/m.  
штапик стеклопакета до 20mm      Bec : 178 gr/m.  
مثبت الزجاج للزجاج المزدوج ٢٠ ملم      الوزن : ١٧٨ غم

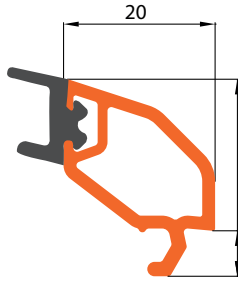
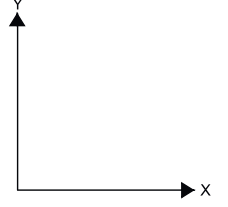

10

## GR 602108

Tek Cam Çıtası Profili      Ağırılık : 250 gr/m.  
Single Glazing Bead      Weight : 250 gr/m.  
مثبت الزجاج للزجاج ٢٥٠ ملم      Bec Bec :  
250 gr/m.      الوزن : ٢٥٠ غم

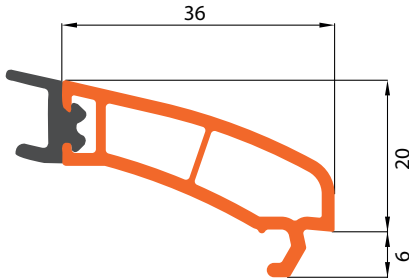

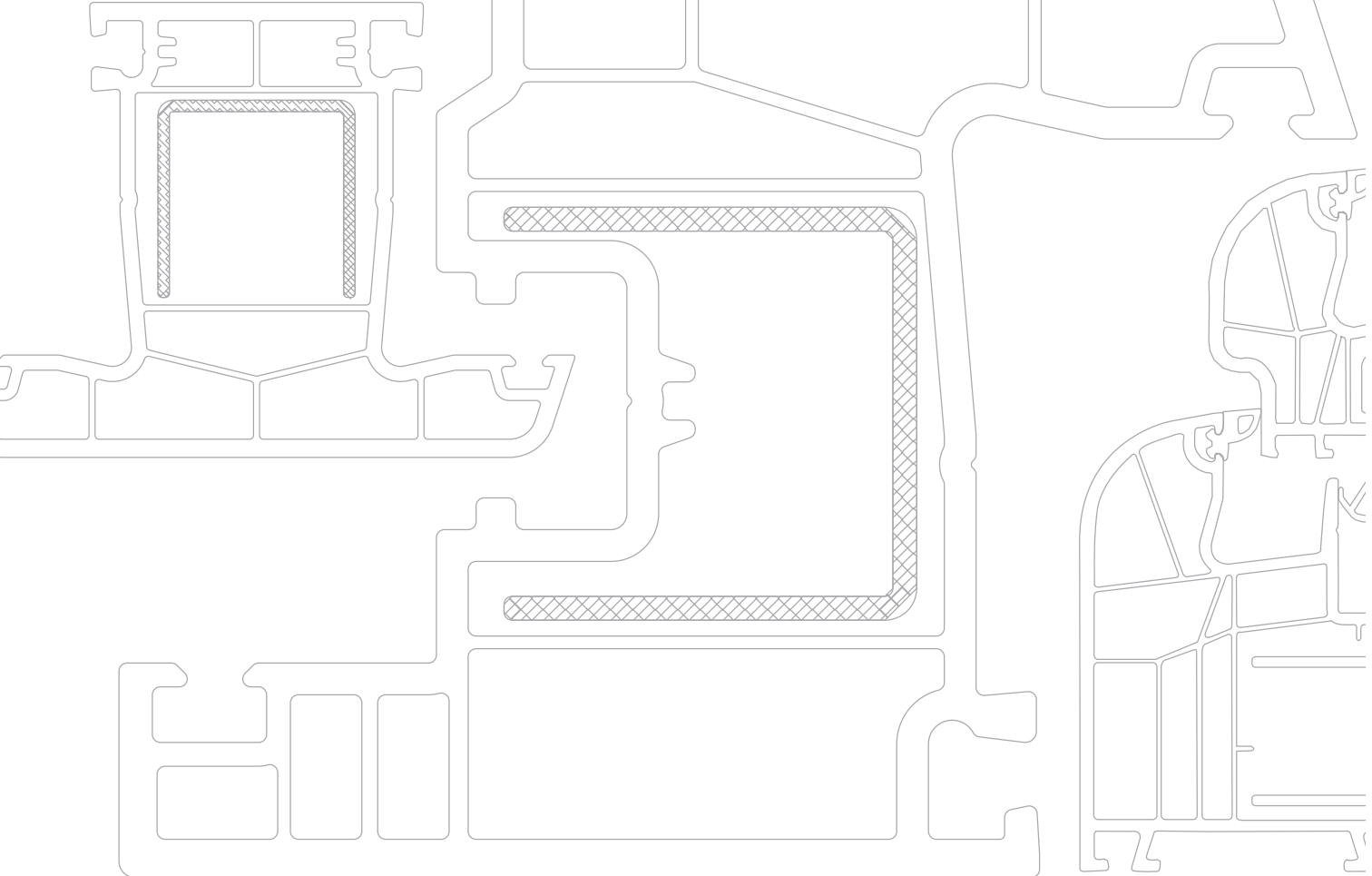

POYRAZ

SERISI

# BESSERHAUS

PVC DOOR AND WINDOWS SYSTEM

## GR 602101-C

Kasa Profili

Frame

Pama

بروفيل الاطار

Ağırlık : 890 gr/m.

Weight : 890 gr/m.

Bec : 890 gr/m.

الوزن : ٩٢٠ غم

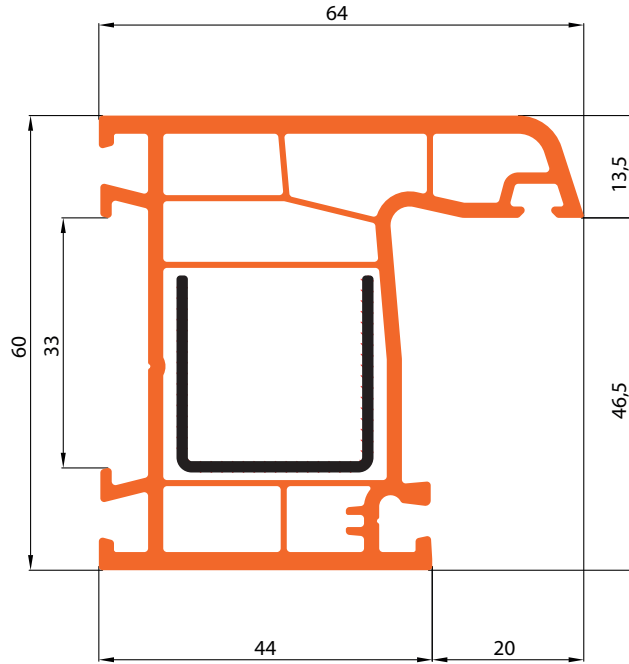
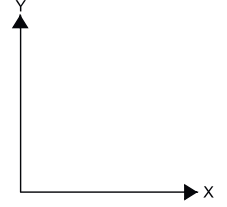

12

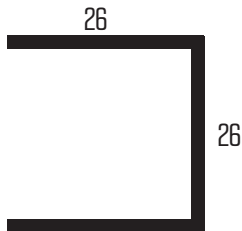

S= 1.20 mm 692 gr/mt  $I_x= 1,005 \text{ cm}^4$   $I_y= 0,613 \text{ cm}^4$

S= 1.50 mm 866 gr/mt  $I_x= 1,295 \text{ cm}^4$   $I_y= 0,780 \text{ cm}^4$

S= 2.00 mm 1.155 gr/mt  $I_x= 1,824 \text{ cm}^4$   $I_y= 1,092 \text{ cm}^4$

## GR 602102-C

Kanat Profil	Ağırlık	: 1013 gr/m.
Sash	Weight	: 1013 gr/m.
створка	Вес	: 1013 gr/m.
بروفيل الضلعة	الوزن	: ١١٥٠ غم

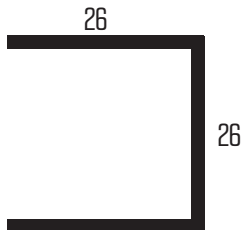
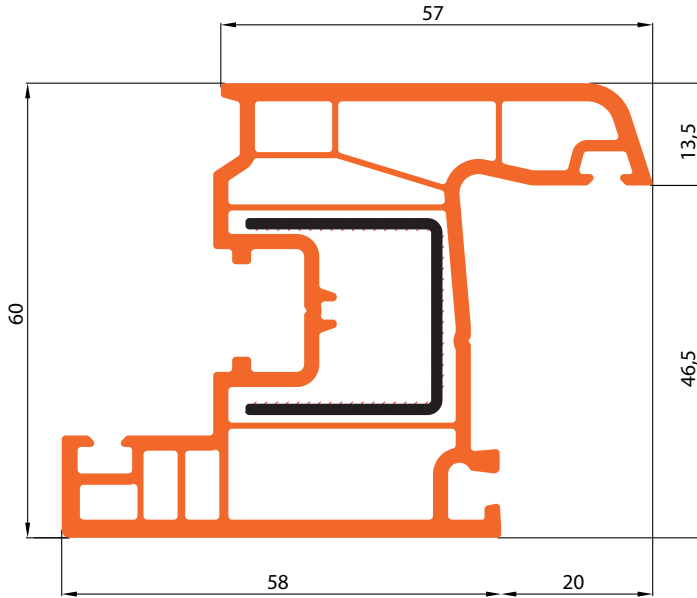
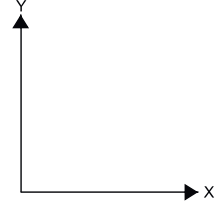

S= 1.20 mm	692 gr/mt	I <sub>x</sub> = 1,005 cm <sup>4</sup>	I <sub>y</sub> = 0,613 cm <sup>4</sup>
S= 1.50 mm	866 gr/mt	I <sub>x</sub> = 1,295 cm <sup>4</sup>	I <sub>y</sub> = 0,780 cm <sup>4</sup>
S= 2.00 mm	1.155 gr/mt	I <sub>x</sub> = 1,824 cm <sup>4</sup>	I <sub>y</sub> = 1,092 cm <sup>4</sup>

# BESSERHAUS

PVC DOOR AND WINDOWS SYSTEM

## GR 602103-C

Ortakayıt Profili	Ağırlık	: 1005 gr/m.
Mullion	Weight	: 1005 gr/m.
импост	Вес	: 1005 gr/m.
بروفیل تي	الوزن	: ۱۱۱۱ غم

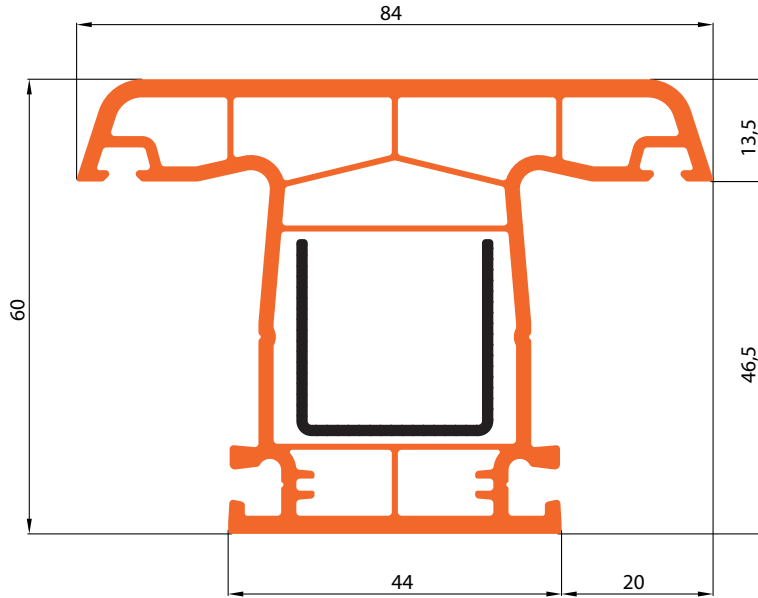
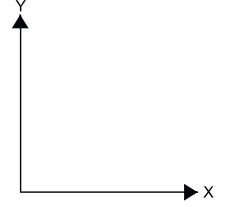

14

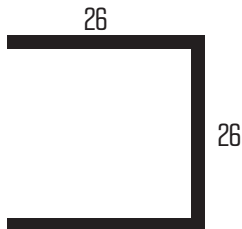

S= 1.20 mm	692 gr/mt	$I_x = 1,005 \text{ cm}^4$	$I_y = 0,613 \text{ cm}^4$
S= 1.50 mm	866 gr/mt	$I_x = 1,295 \text{ cm}^4$	$I_y = 0,780 \text{ cm}^4$
S= 2.00 mm	1.155 gr/mt	$I_x = 1,824 \text{ cm}^4$	$I_y = 1,092 \text{ cm}^4$

## GR 602105-C

İçe Açılır Kapı Kanat Profili

In turn Door Sash Profile

дверная створка открытие вовнутрь

بروفيل ضلفة الباب الفته الى الداخل

Ağırlık : 1234 gr/m.

Weight : 1234 gr/m.

Вес : 1234 gr/m.

الوزن : ١٢٣٧٨ غم

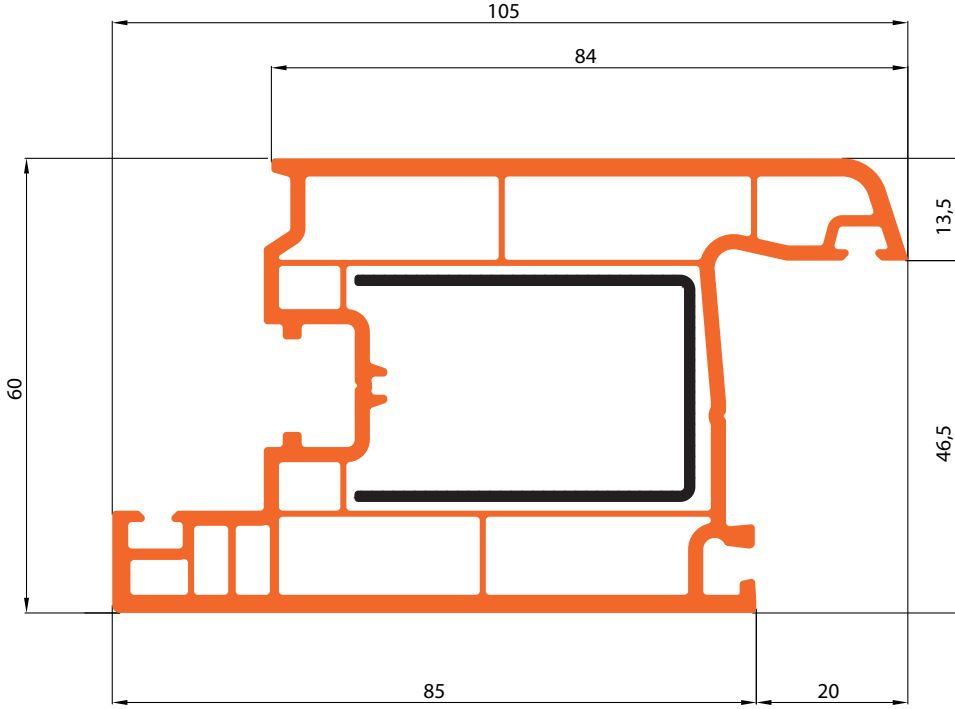
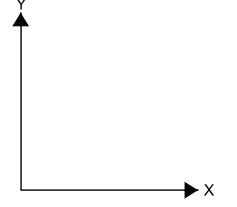

15



45

S= 1.20 mm 1.067 gr/mt  $I_x= 2,919 \text{ cm}^4$   $I_y= 2,304 \text{ cm}^4$

S= 1.50 mm 1.533 gr/mt  $I_x= 3,689 \text{ cm}^4$   $I_y= 2,951 \text{ cm}^4$

S= 2.00 mm 1.778 gr/mt  $I_x= 5,062 \text{ cm}^4$   $I_y= 4,110 \text{ cm}^4$

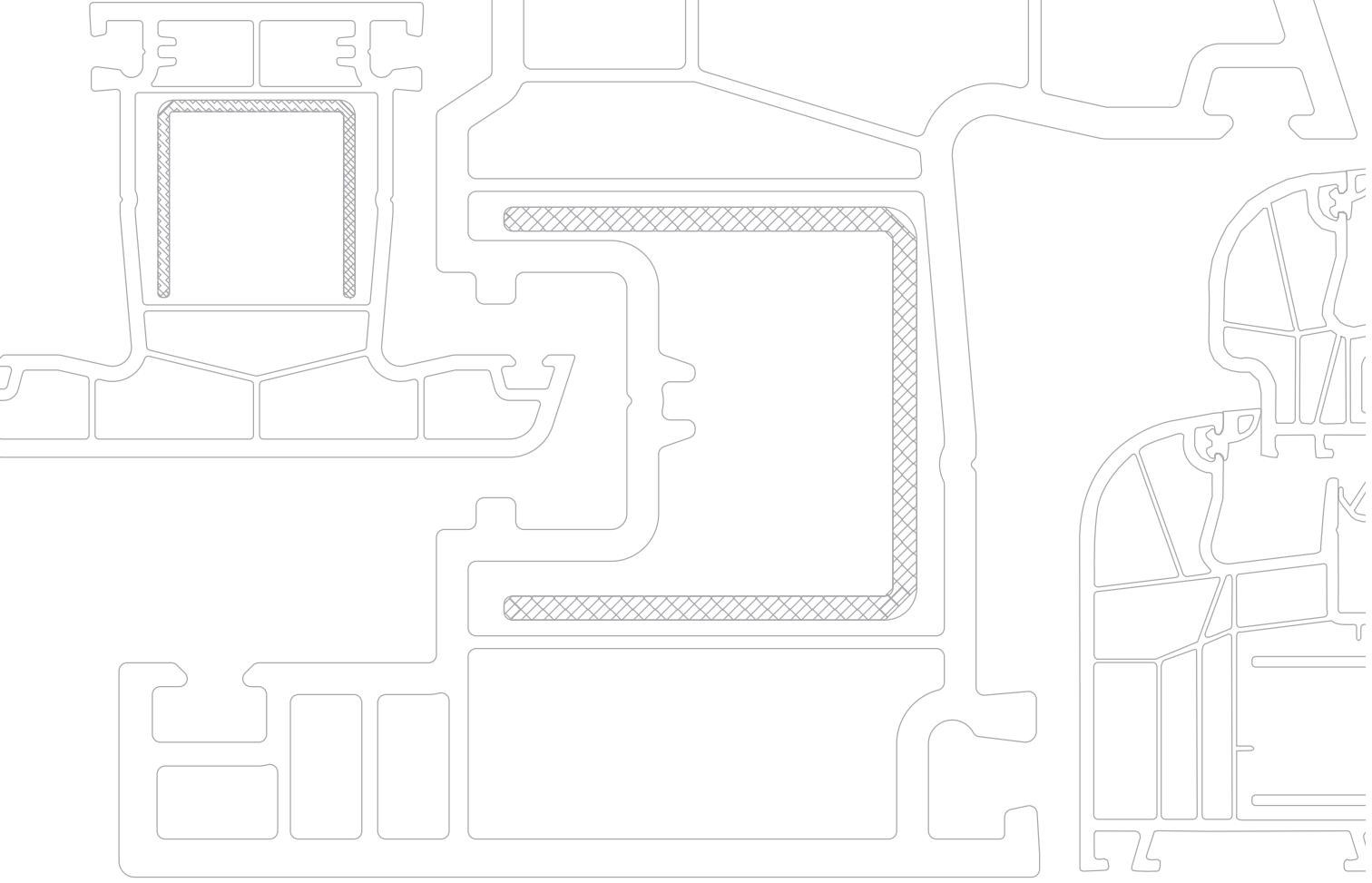

DENİZ

SERİSİ



# BESSERHAUS

PVC DOOR AND WINDOWS SYSTEM

## GR 702111

Kasa Profili	Ağırlık	: 1085 gr/m.
Frame	Weight	: 1085 gr/m.
Pama	Bec	: 1085 gr/m.
بروفيل الاطار	الوزن	: ١٠٨٥ غم

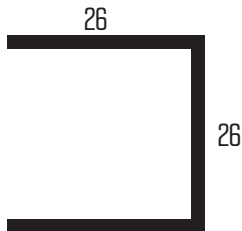
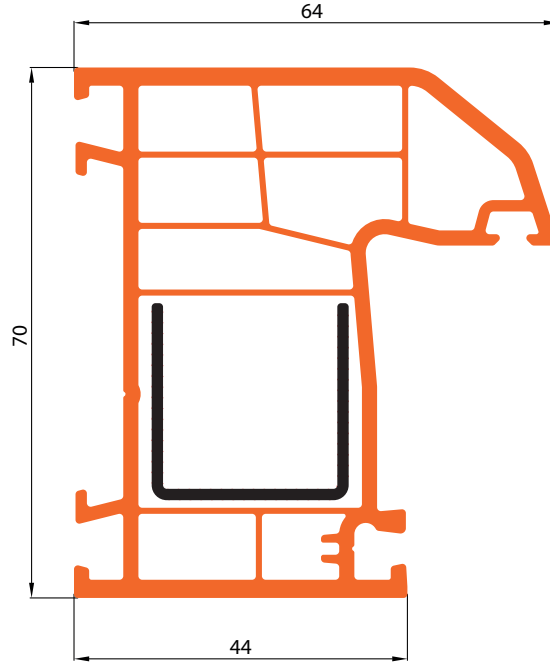
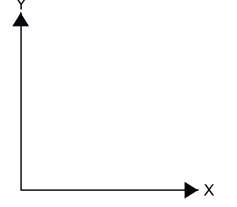

S= 1.20 mm	692 gr/mt	I <sub>x</sub> = 1,005 cm <sup>4</sup>	I <sub>y</sub> = 0,613 cm <sup>4</sup>
S= 1.50 mm	866 gr/mt	I <sub>x</sub> = 1,295 cm <sup>4</sup>	I <sub>y</sub> = 0,780 cm <sup>4</sup>
S= 2.00 mm	1.155 gr/mt	I <sub>x</sub> = 1,824 cm <sup>4</sup>	I <sub>y</sub> = 1,092 cm <sup>4</sup>

# BESSERHAUS

PVC DOOR AND WINDOWS SYSTEM

Kanat Profil Ağırlık : 1200 gr/m.  
Sash Weight : 1200 gr/m.  
створка Вес : 1200 gr/m.  
بروفيل الضلفة الوزن : ١٢٠٠

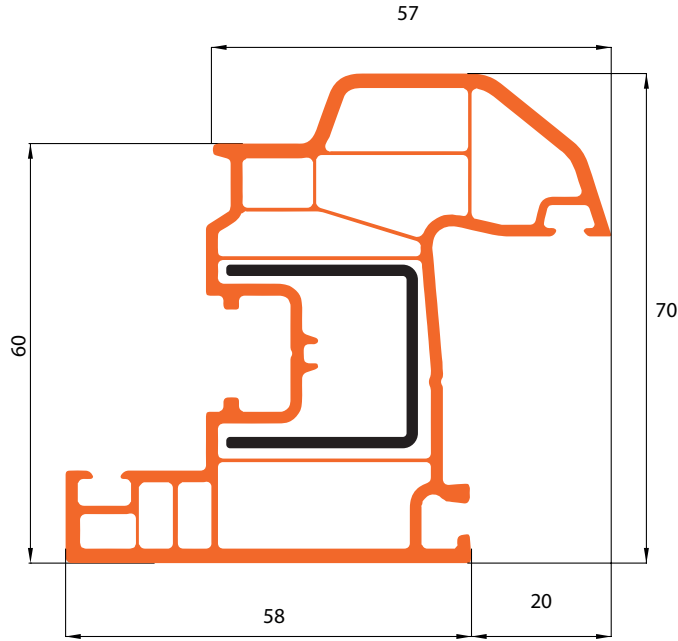
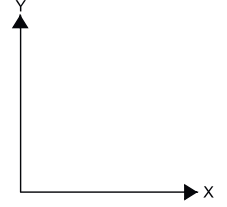

18

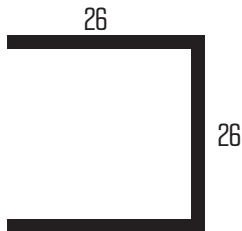

S= 1.20 mm	692 gr/mt	Ix= 1,005 cm <sup>4</sup>	Iy= 0,613 cm <sup>4</sup>
S= 1.50 mm	866 gr/mt	Ix= 1,295 cm <sup>4</sup>	Iy= 0,780 cm <sup>4</sup>
S= 2.00 mm	1.155 gr/mt	Ix= 1,824 cm <sup>4</sup>	Iy= 1,092 cm <sup>4</sup>

# BESSERHAUS

PVC DOOR AND WINDOWS SYSTEM

## GR 702113

Ortakayıt Profili

Mullion

импост

بروفيل تي

Ağırlık : 1222 gr/m.

Weight : 1222 gr/m.

Bec : 1222 gr/m.

الوزن : ١٢٢٢

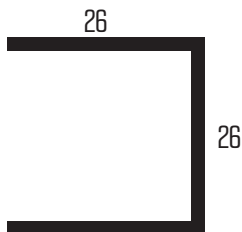
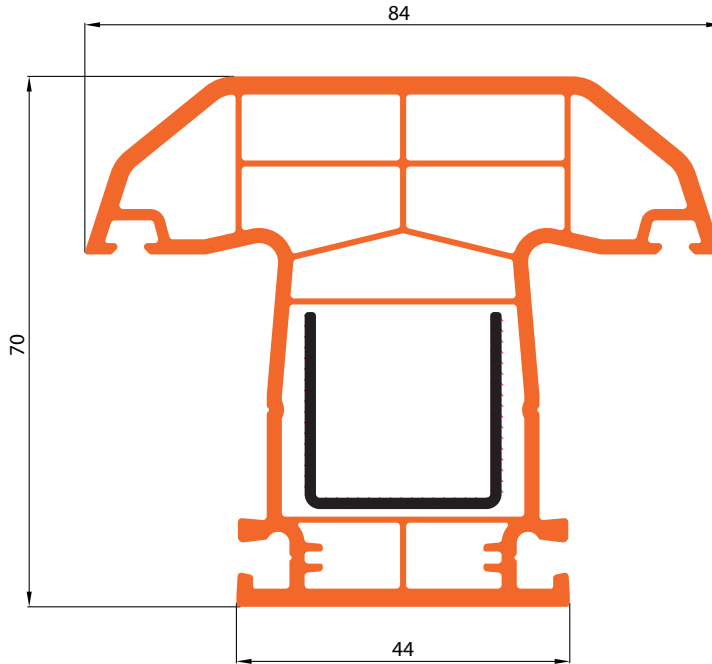
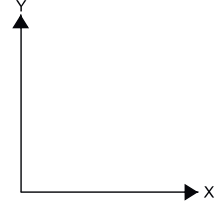

S= 1.20 mm    692 gr/mt     $I_x = 1,005 \text{ cm}^4$      $I_y = 0,613 \text{ cm}^4$

S= 1.50 mm    866 gr/mt     $I_x = 1,295 \text{ cm}^4$      $I_y = 0,780 \text{ cm}^4$

S= 2.00 mm    1.155 gr/mt     $I_x = 1,824 \text{ cm}^4$      $I_y = 1,092 \text{ cm}^4$

# BESSERHAUS

PVC DOOR AND WINDOWS SYSTEM

## GR 702114 - Pervazlı Kasa Profili

Pervazlı Kasa Profili  
Frame with Cornice Profile  
Рама с откосом  
بروفیل الإطار بکشف

Ağırlık : 1140 gr/m.  
Weight : 1140 gr/m.  
Вес : 1140 гр/м  
الوزن : 1140 غرام / م.

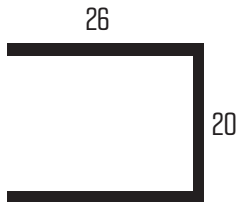
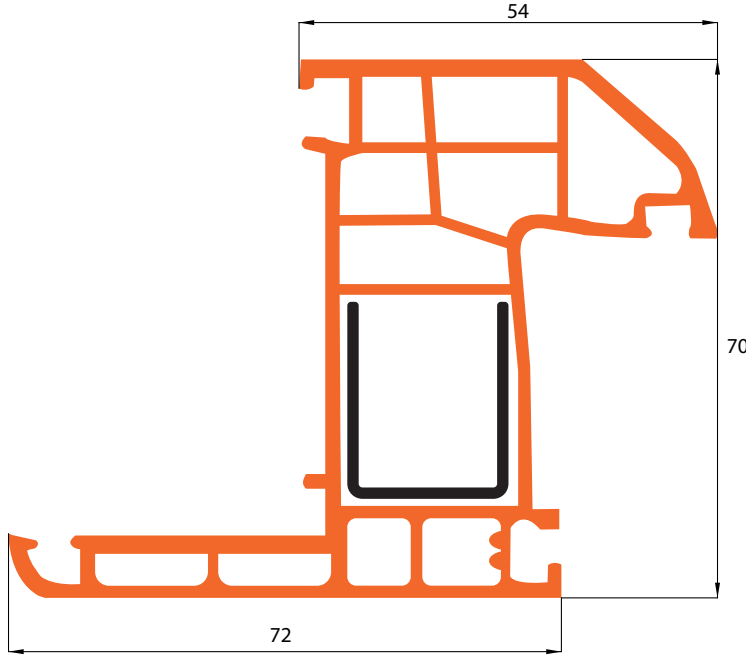
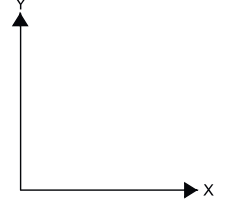

S= 1.20 mm 636 gr/mt  $I_x = 0,549 \text{ cm}^4$   $I_y = 0,556 \text{ cm}^4$

S= 1.50 mm 796 gr/mt  $I_x = 0,713 \text{ cm}^4$   $I_y = 0,707 \text{ cm}^4$

S= 2.00 mm 1.060 gr/mt  $I_x = 1,019 \text{ cm}^4$   $I_y = 0,992 \text{ cm}^4$

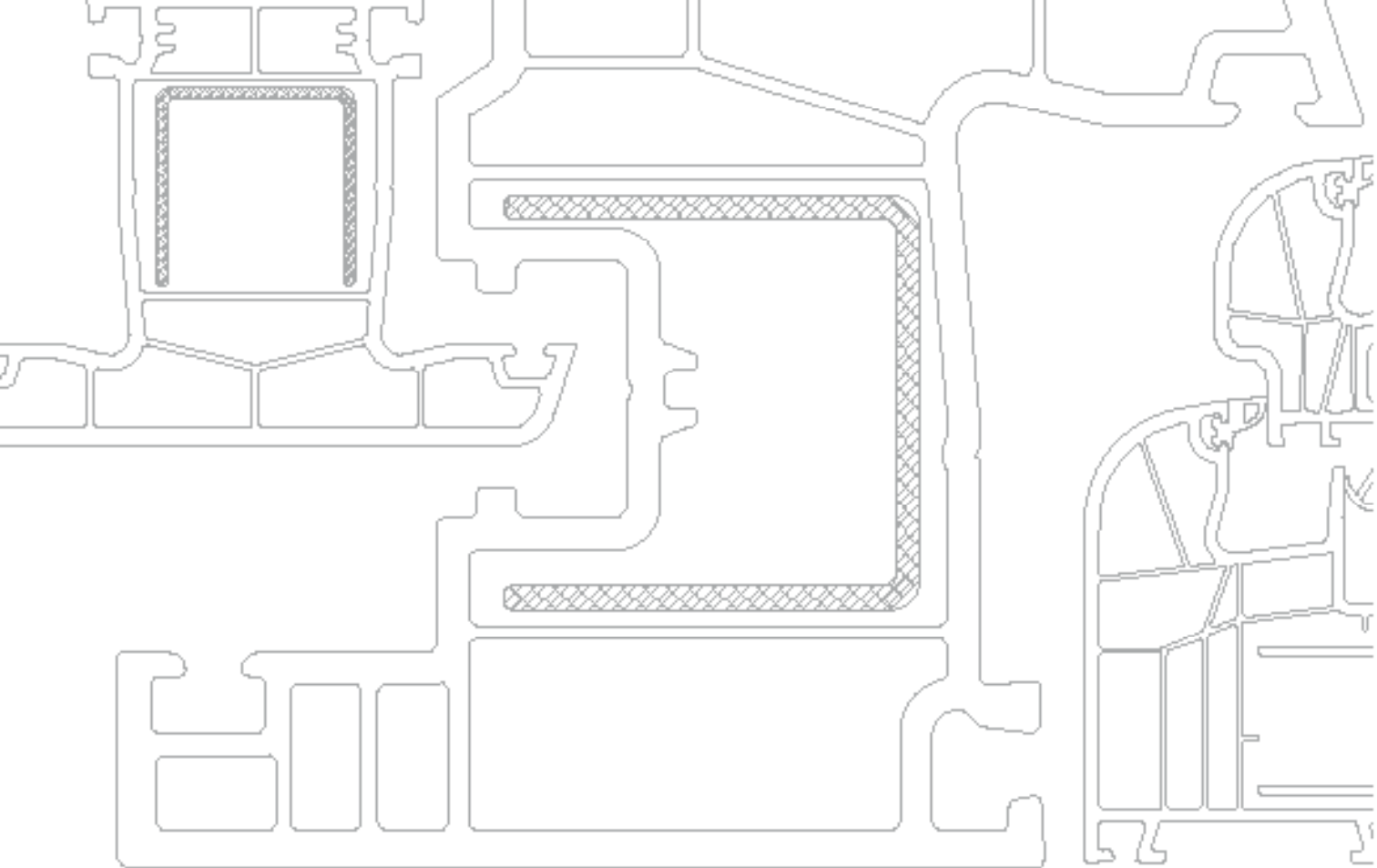

**DICLE**

SERISI

# BESSERHAUS

PVC DOOR AND WINDOWS SYSTEM

## GR 703111 - Kasa Profili 70mm

Kasa Profili  
Frame with Cornice Profile  
Рама с откосом  
بروفيل الإطار بكشف

Ağırlık : 935 gr/m.  
Weight : 935 gr/m.  
Вес : 935 гр/м  
الوزن : 935 غرام / م.

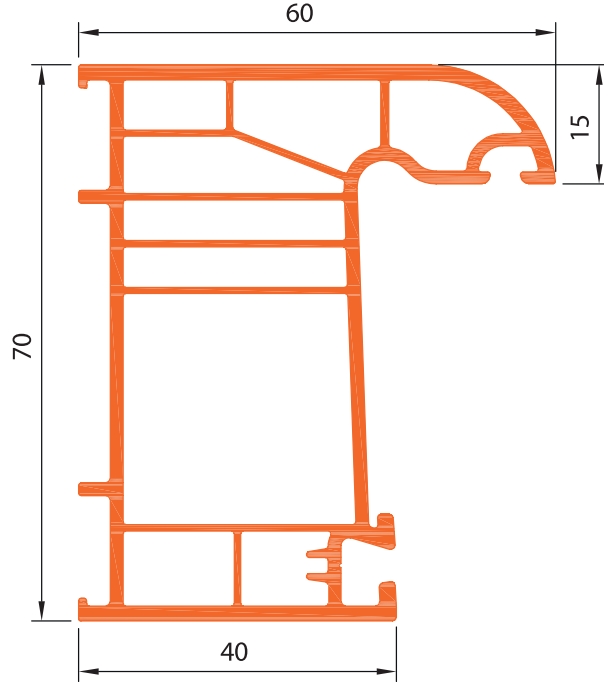
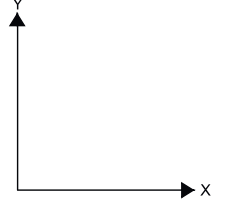

## GR 703112 - Pencere Kanat Profili 70mm

Kasa Profili

Sash Profile

Рама с откосом

بروفيل الإطار بكشف

Ağırlık : 1120 gr/m.

Weight : 1120 gr/m.

Вес : 1120 гр/м

الوزن : 1120 غرام / م.

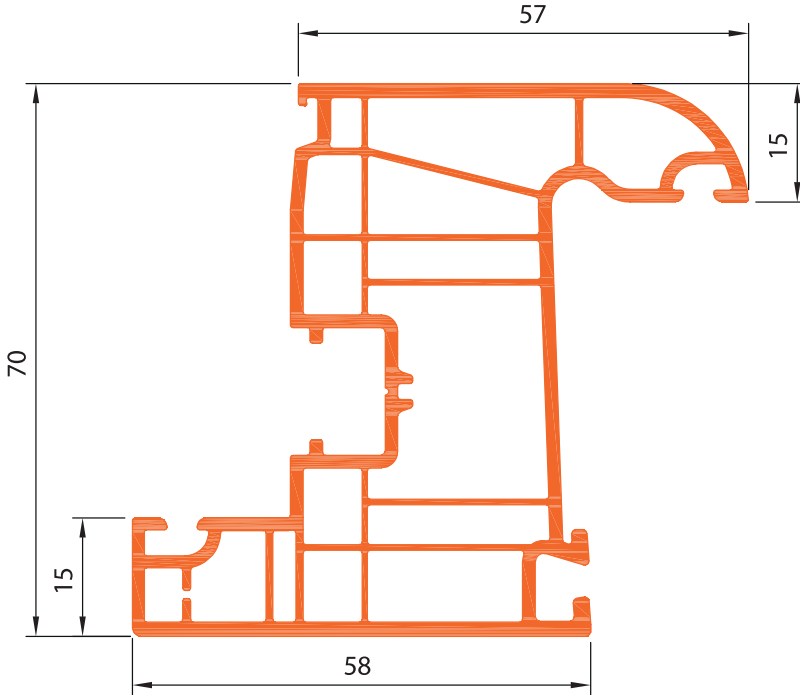
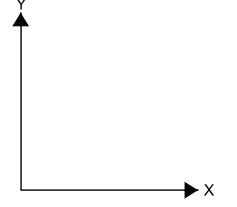

# BESSERHAUS

PVC DOOR AND WINDOWS SYSTEM

## GR 703113 - Orta Kayıt Profili 70mm

Kasa Profili

Mullion Profile

Рама с откосом

بروفيل الإطار بكشف

Ağırlık : 1070 gr/m.

Weight : 1070 gr/m.

Вес : 1070 гр/м

الوزن : 1070 غرام / م.

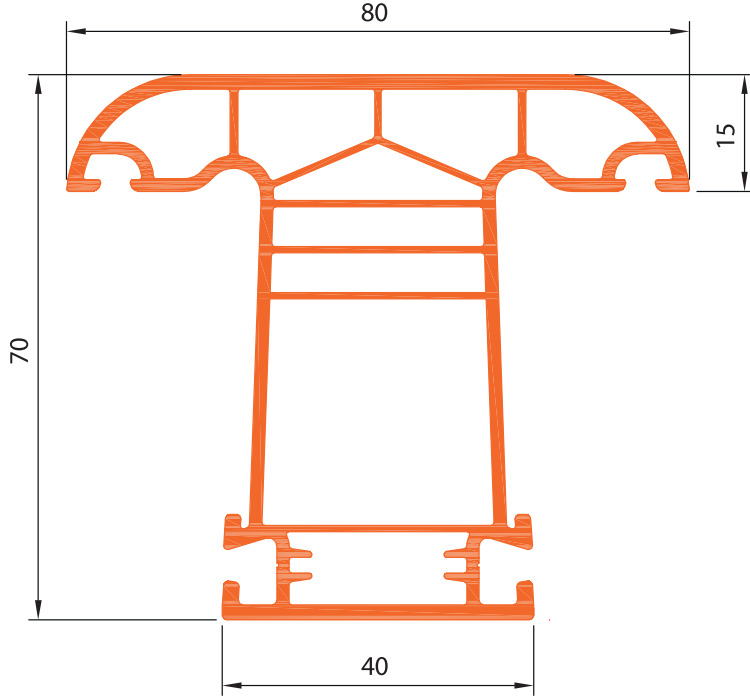
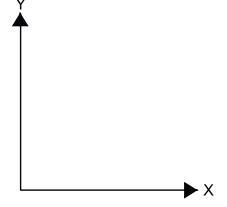



## GR 703114 - Pervazlı Kasa Profili 70mm

Kasa Profili

Frame with Cornice Profile

Рама с откосом

بروفيل الإطار بكشف

Ağırlık : 1030 gr/m.

Weight : 1030 gr/m.

Вес : 1030 гр/м

الوزن : 1030 غرام / م.

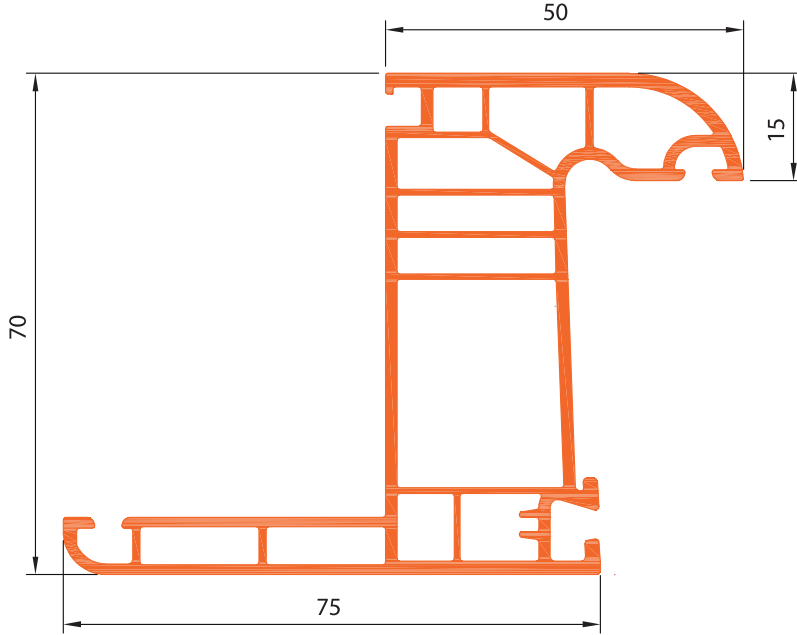
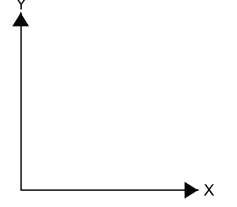

# BESSERHAUS

PVC DOOR AND WINDOWS SYSTEM

## GR 703115 - İçe Açılım Kapı Kanat Profili 70mm

Kasa Profili  
Door Sash Profile  
Рама с откосом  
بروفيل الإطار بكشف

Ağırlık : 1430 gr/m.  
Weight : 1430 gr/m.  
Вес : 1430 гр/м  
الوزن : 1430 غرام / م.

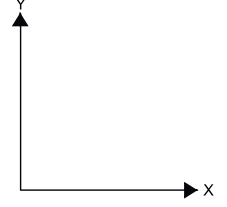

26

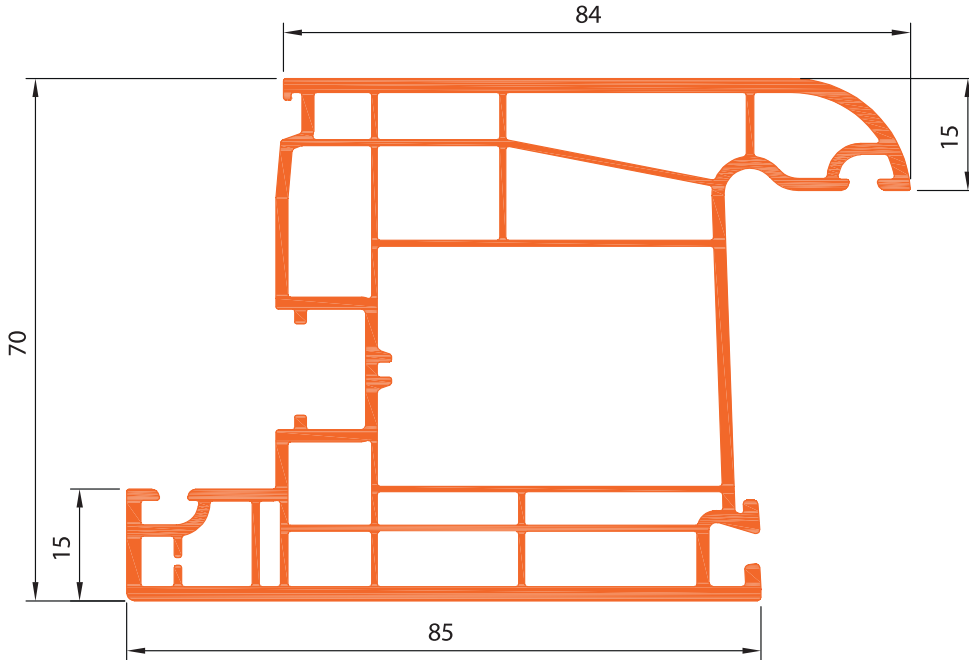

## GR 703116 - Çift Cam Çıtası 20mm

Kasa Profili

Frame with Cornice Profile

Рама с откосом

بروفيل الإطار بكشف

Ağırlık : 260 gr/m.

Weight : 260 gr/m.

Вес : 260 гр/м

الوزن : 260 غرام / م.

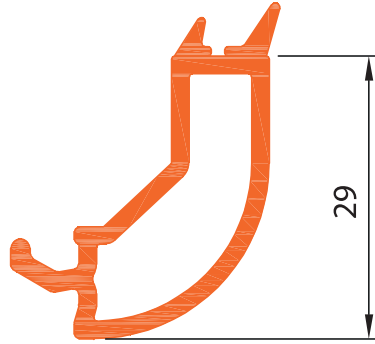
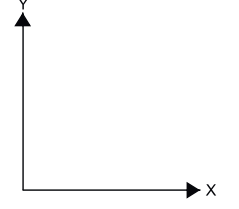

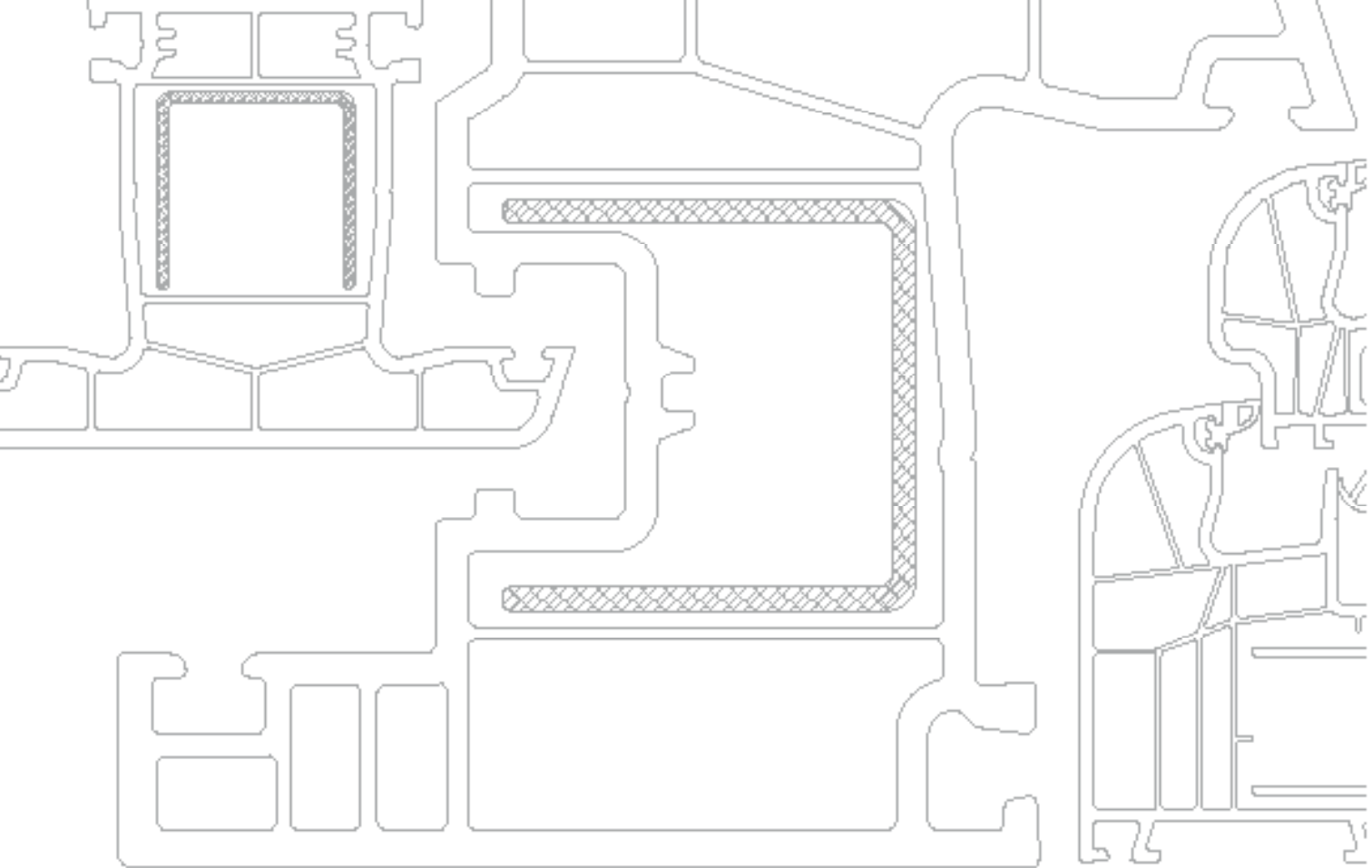

**DICLE A<sup>+</sup>**

**SERISI**

## GR 701112 - Pencere Kanat Profili 70mm

Kasa Profili

Sash Profile

Рама с откосом

بروفيل الإطار بكشف

Ağırlık : 1480 gr/m.

Weight : 1480 gr/m.

Вес : 1480 гр/м

الوزن : 1480 غرام / م.

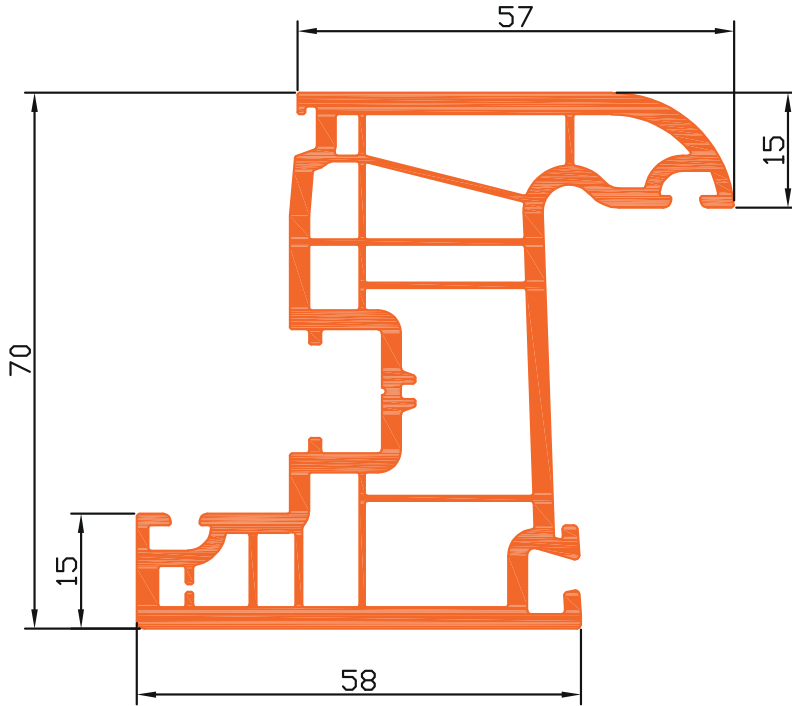
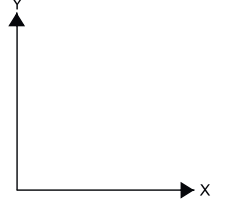

# BESSERHAUS

PVC DOOR AND WINDOWS SYSTEM

## GR 701113 - Orta Kayıt Profili 70mm

Kasa Profili

Mullion Profile

Рама с откосом

بروفيل الإطار بكشف

Ağırlık : 1390 gr/m.

Weight : 1390 gr/m.

Вес : 1390 гр/м

الوزن : 1390 غرام / م.

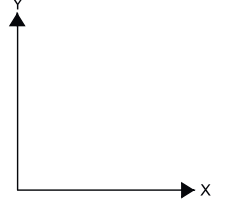

30

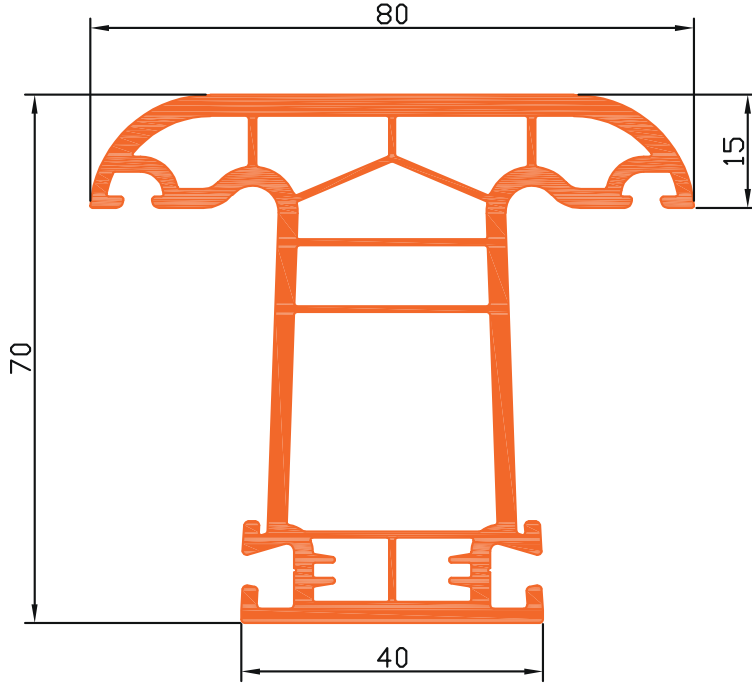

## GR 701114 - Pervazlı Kasa Profili 70mm

Kasa Profili

Frame with Cornice Profile

Рама с откосом

بروفيل الإطار بكشف

Ağırlık : 1340 gr/m.

Weight : 1340 gr/m.

Вес : 1340 гр/м

الوزن : 1340 غرام / م.

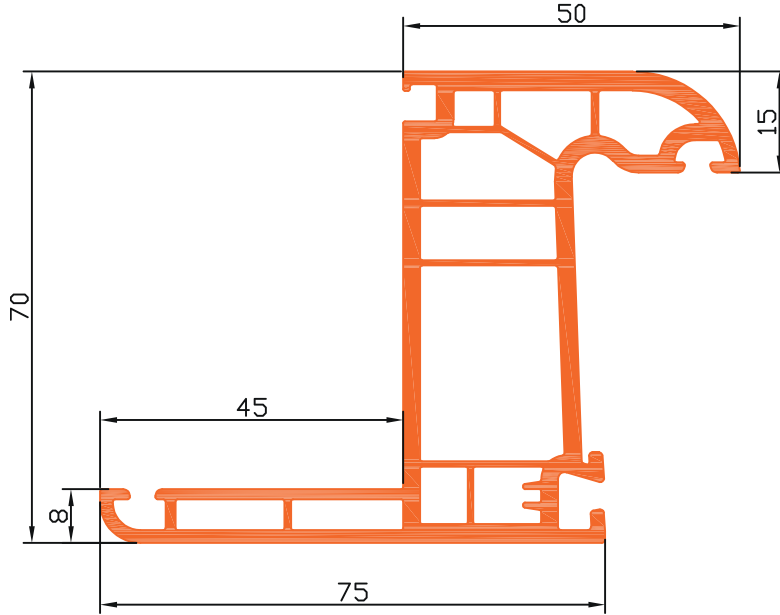
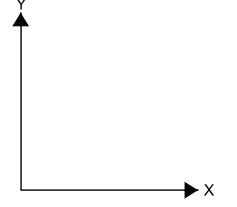

# BESSERHAUS

PVC DOOR AND WINDOWS SYSTEM

## GR 701115 - İçe Açılım Kapı Kanat Profili 70mm

Kasa Profili  
Door Sash Profile  
Рама с откосом  
بروفيل الإطار بكشف

Ağırlık : 1850 gr/m.  
Weight : 1850 gr/m.  
Вес : 1850 гр/м  
الوزن : 1430 غرام / م.

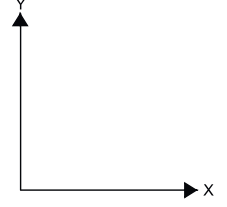

32

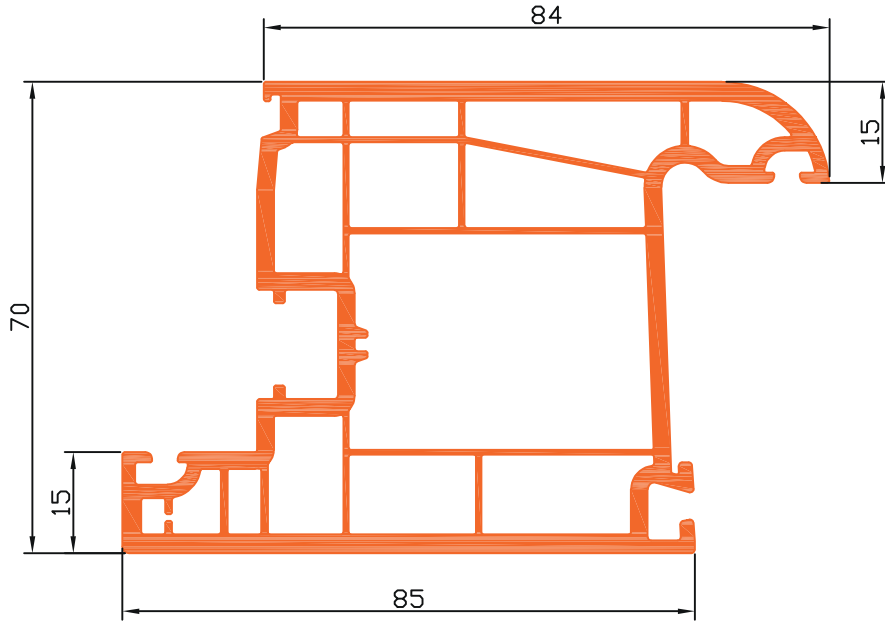



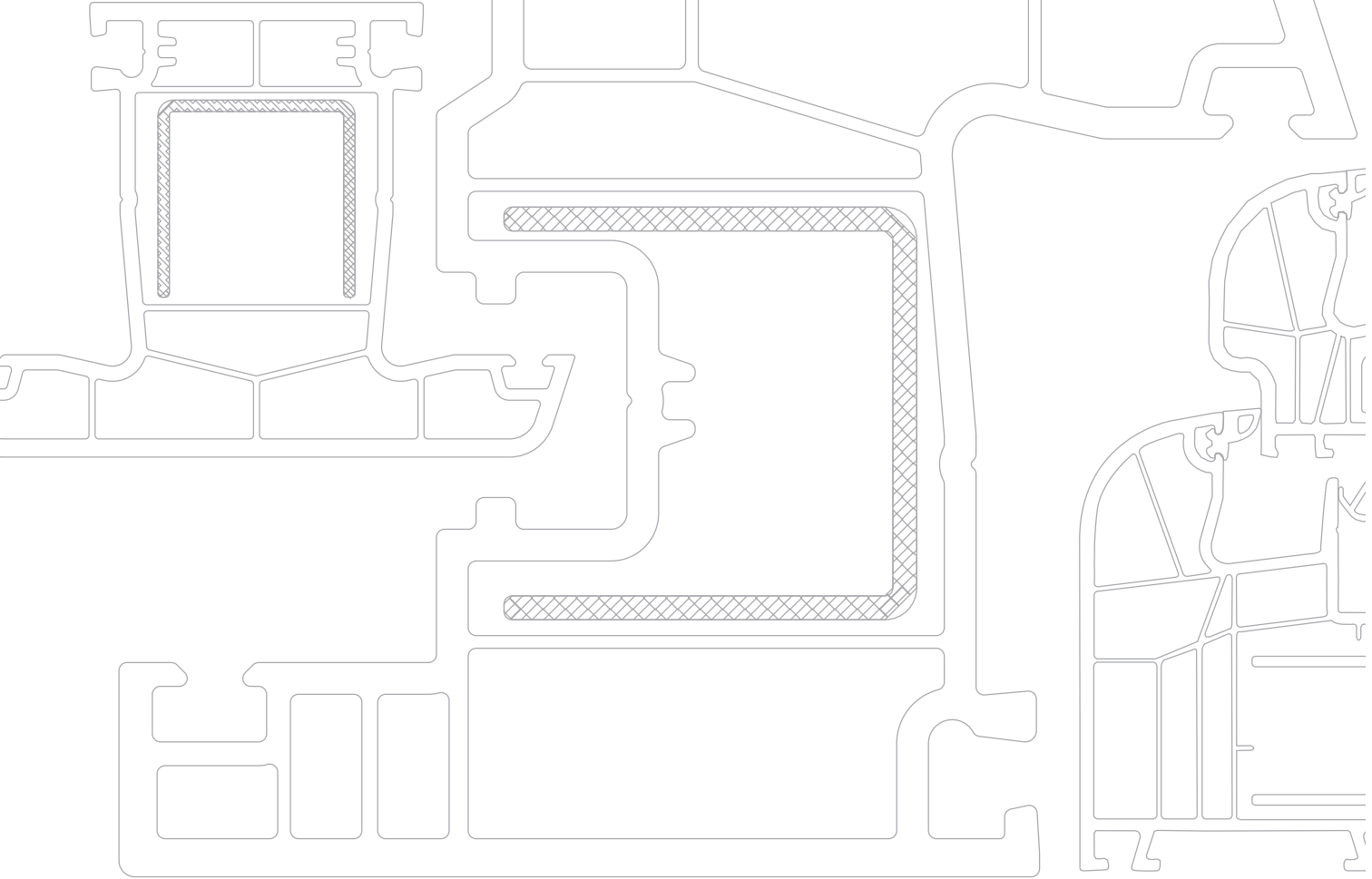

OKYANUS

SERISI

# BESSERHAUS

PVC DOOR AND WINDOWS SYSTEM

## GR 802101

Kasa Profili	Ağırlık	: 1546gr/m
Frame	Weight	: 1546gr/m
Pama	Bec	: 1546gr/m
بروفيل الاطار	الوزن	: ١٥٤٦ غام

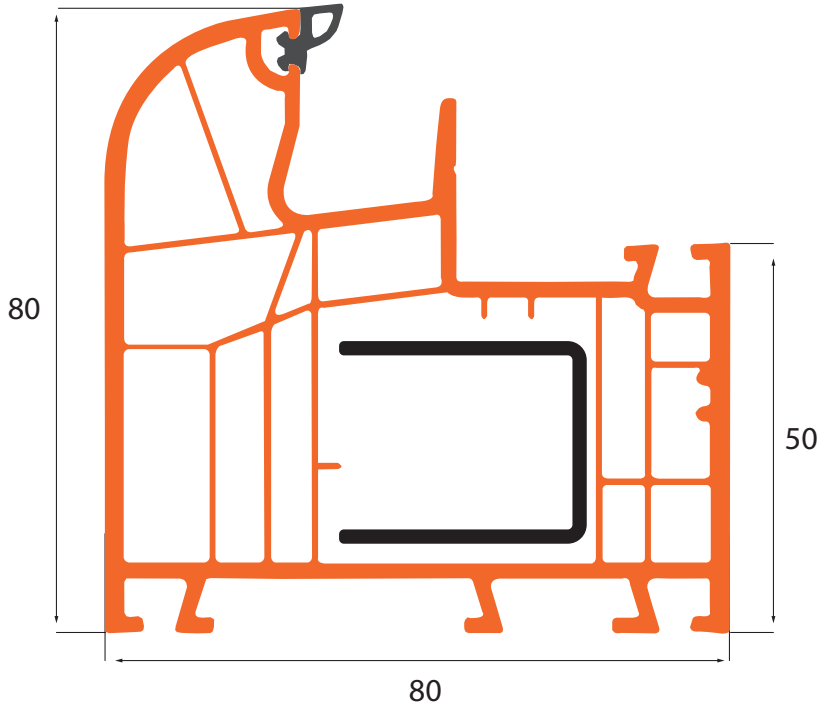
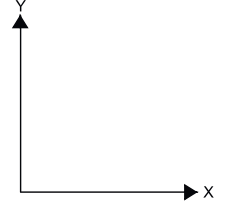

34

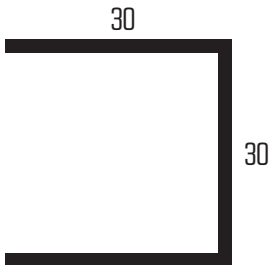

S= 1.20 mm	805 gr/mt	$I_x = 1,663 \text{ cm}^4$	$I_y = 0,988 \text{ cm}^4$
S= 1.50 mm	1.006 gr/mt	$I_x = 2,030 \text{ cm}^4$	$I_y = 1,218 \text{ cm}^4$
S= 2.00 mm	1.341 gr/mt	$I_x = 2,586 \text{ cm}^4$	$I_y = 1,576 \text{ cm}^4$

GR812102

Damlıklı Kanat Profil Ağırlık : 1398gr/m  
Sash Weight :1398 gr/m  
Створка Вес : 1398 gr/m  
الوزن بروفيل الضلعة 1398

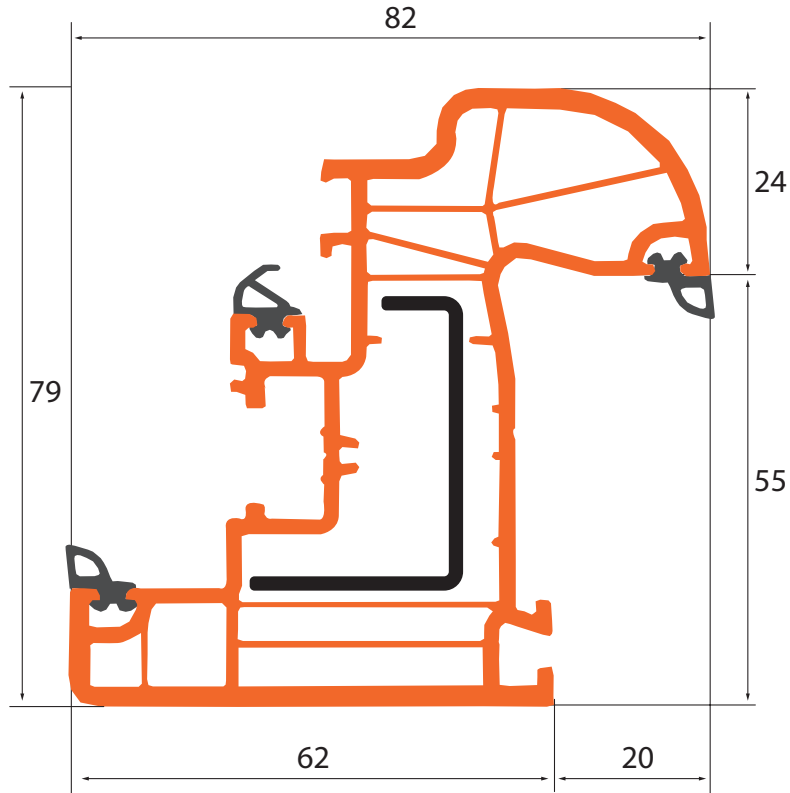
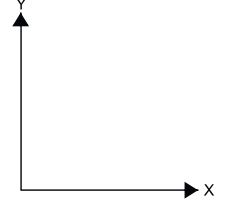

S= 1.20 mm	571 gr/mt	Ix= 1,113 cm <sup>4</sup>	Iy= 0,270 cm <sup>4</sup>
S= 1.50 mm	713 gr/mt	Ix= 1,353cm <sup>4</sup>	Iy= 0,328 cm <sup>4</sup>
S= 2.00 mm	952 gr/mt	Ix= 1,721 cm <sup>4</sup>	Iy= 0,421 cm <sup>4</sup>

# BESSERHAUS

PVC DOOR AND WINDOWS SYSTEM

GR 812103

Ortakayıt Profili  
Mullion

ИМПОСТ

بروفیل ٹی

Ağırlık : 1780 gr/m

Weight: 1780 gr/m

Bec : 1780 gr/m

الوزن ۱۷۸۰ غم

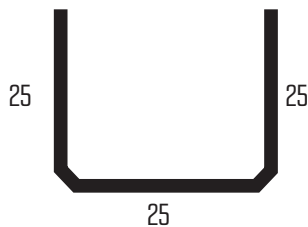
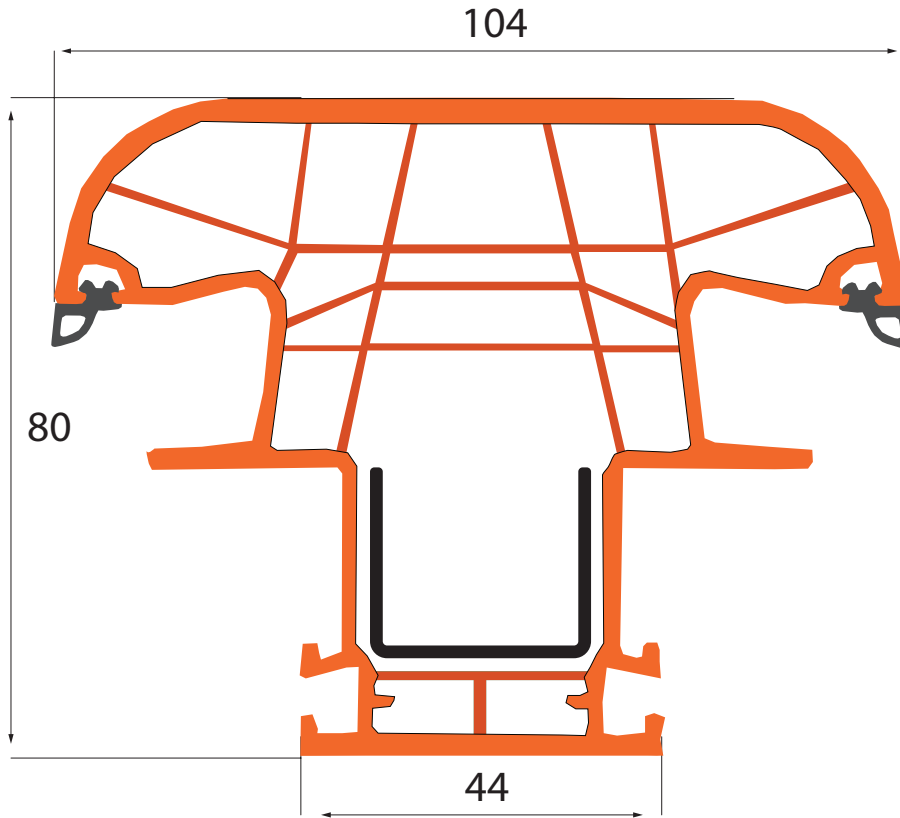
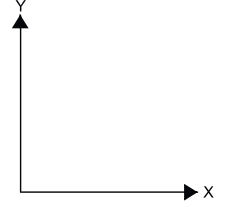

S= 1.20 mm	664 gr/mt	$I_x = 0,965 \text{ cm}^4$	$I_y = 0,577 \text{ cm}^4$
S= 1.50 mm	830 gr/mt	$I_x = 1,169 \text{ cm}^4$	$I_y = 0,707 \text{ cm}^4$
S= 2.00 mm	1.108 gr/mt	$I_x = 1,480 \text{ cm}^4$	$I_y = 0,913 \text{ cm}^4$

GR802104

içe Açılır Kapı Kanat Profili

In turn Door Sash Profile

дверная створка открытие вовнутрь

بروفيل ضلفة الباب الفته الى الداخل

Ağırlık : 1940 gr/m

Weight: 1940 gr/m

Вес : 1940 gr/m

الوزن ١٩٤٠ غم

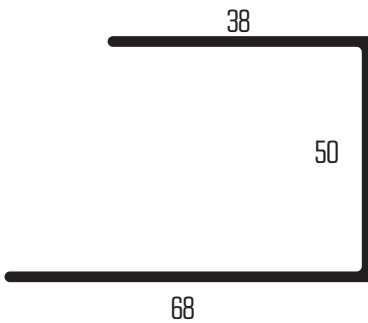
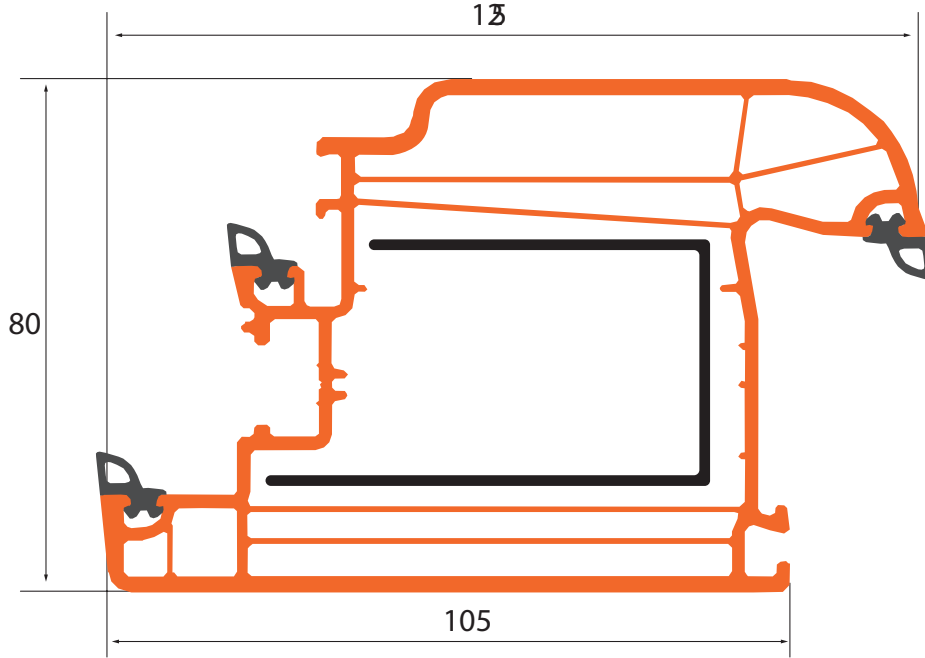
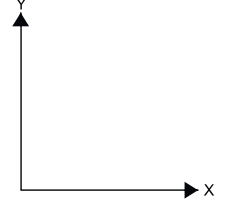

S= 1.20 mm 1,423 gr/mt  $I_x= 8,207 \text{ cm}^4$   $I_y= 4,501 \text{ cm}^4$

S= 1.50 mm 1,778 gr/mt  $I_x= 10,154 \text{ cm}^4$   $I_y= 5,526 \text{ cm}^4$

S= 2.00 mm 2,371 gr/mt  $I_x= 13,310 \text{ cm}^4$   $I_y= 7,150 \text{ cm}^4$

# BESSERHAUS

PVC DOOR AND WINDOWS SYSTEM

GR812105

24 mm Çift Cam Çıtası

Ağırlık : 217 gr/m

Double Glazing Bead For 24mm Weight 217 gr/m

штапик стеклопакета до 24mm

Bec : 217 gr/m

: مثبت الزجاج للزجاج المزدوج ٢٠ ملم غام ٢١٧ الوزن

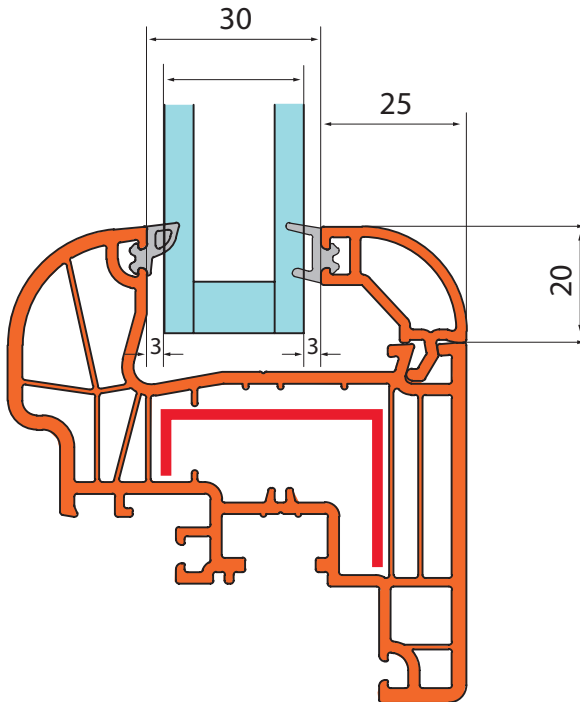
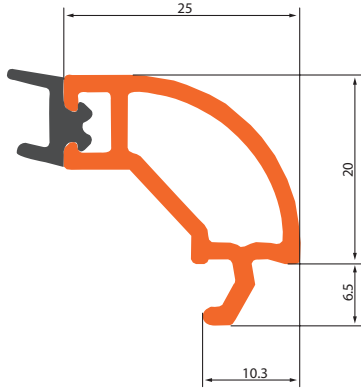
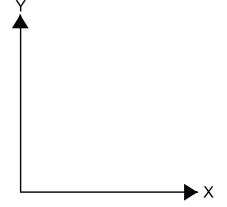

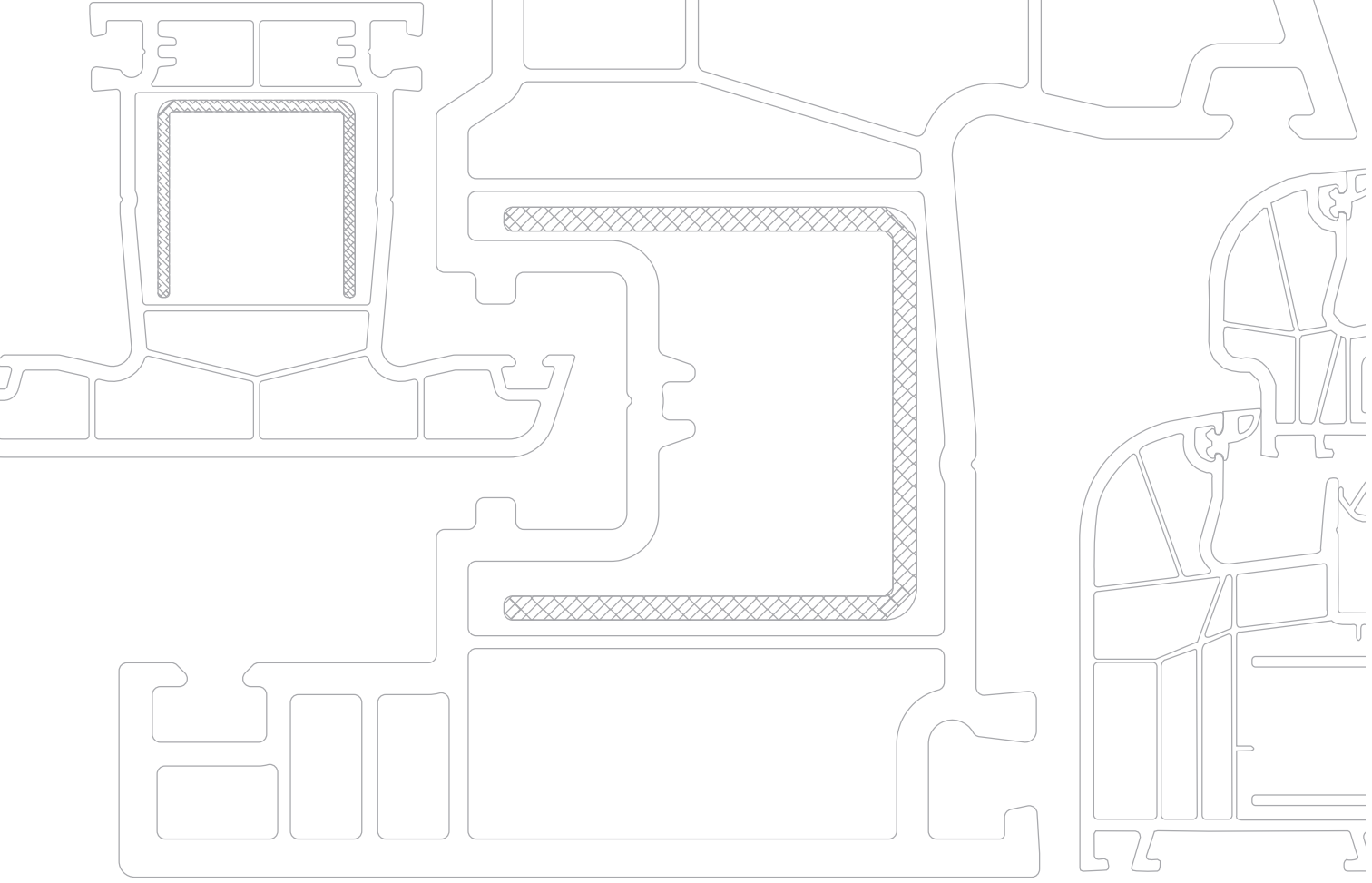

YARDIMCI

PROFİL

# BESSERHAUS

PVC DOOR AND WINDOWS SYSTEM

Kutu Profili                    Ağırılık : 900 gr/m.  
Box Profile                    Weight : //  
Профиль коробка        Вес : 900 гр/м  
بروفيل العتبة                الوزن : ٩٠٠ غ / م

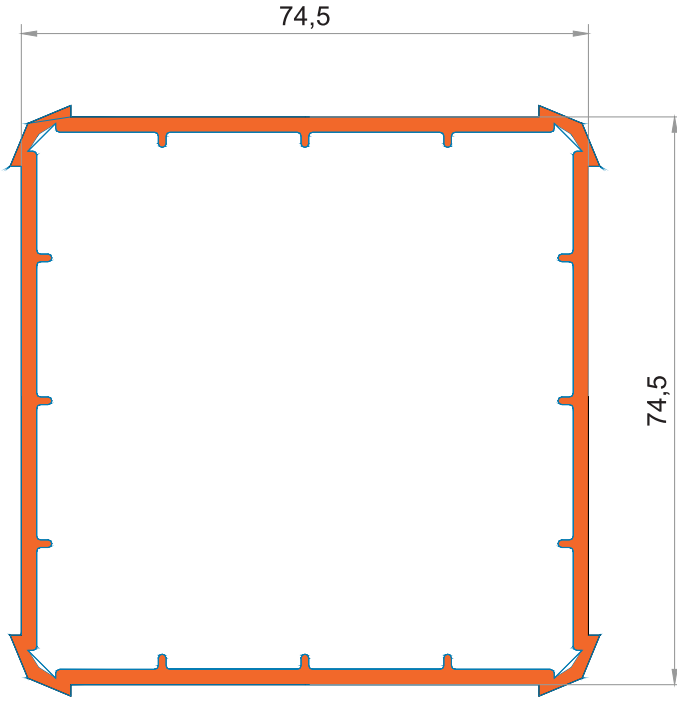
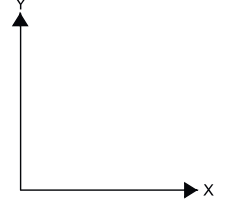

40

Köşe Dönüş Adaptör Profili

Corner Adaptor

Адаптор

بروفيل أدبتر المعدل للزاوية

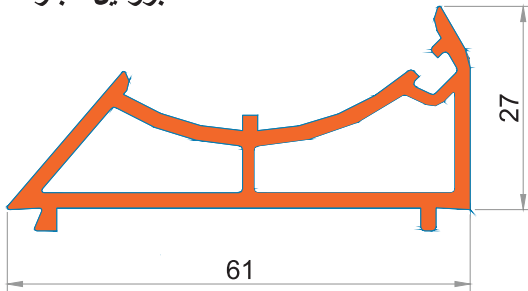



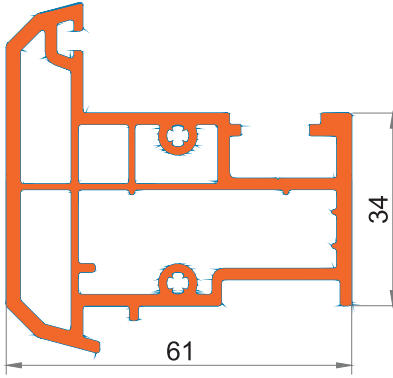

Hareketli Ortakayıt Profili  
False Mullion Profile  
Штупльовый профиль  
بروفيل تي المتحركة

Ağırlık : 1010 gr/m.  
Weight : ''  
Вес : 1010 гр/м  
الوزن : ١٠١٠ غ / م

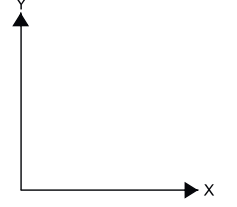

Boru Profili  
Pipe Profile  
Трубный профиль  
بروفيل أنبوب

Ağırlık : 520 gr/m.  
Weight : ''  
Вес : 520 гр/м  
الوزن : ٥٢٠ غ / م

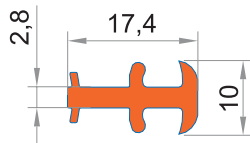
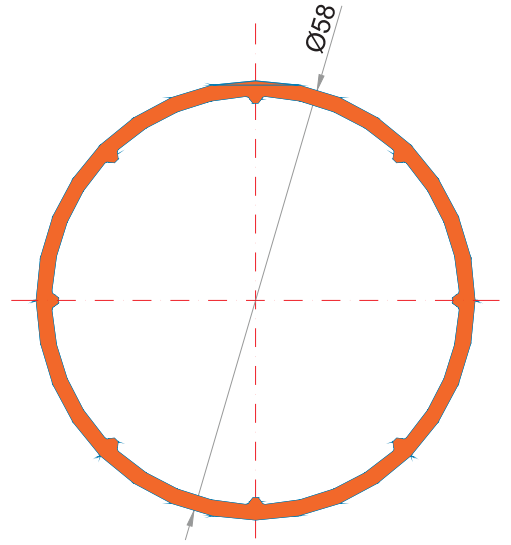

Üniversal Bağ Profili  
Universal Connecting Profile  
Универсальный  
соединительный профиль  
بروفيل الربط أوني وارسال

Pervaz Profili (60x90) (6,5x10,5)  
Cornice Profile (60x90) (6,5x10,5)  
Профиль откоса (60x90) (6,5x10,5)  
بروفيل كشف (60x90)

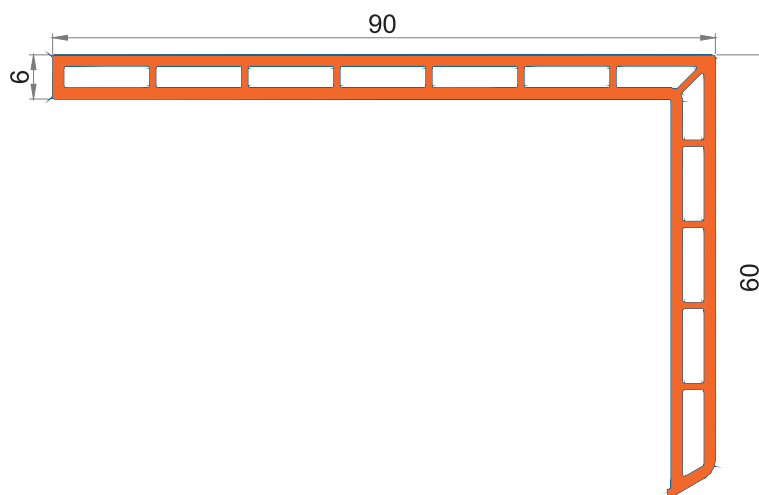
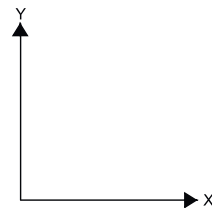

42

Lambiri (Panel) profili  
Panel profile  
Füll - (Panel) profil  
Панель профиль  
بروفيل كشف

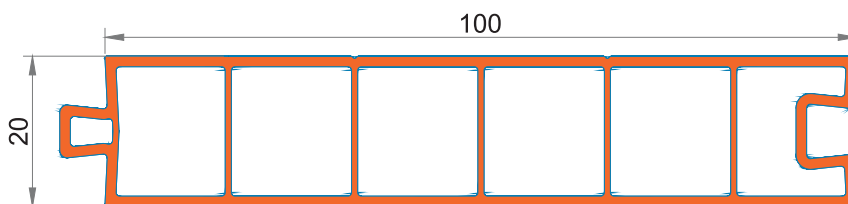

Kasa - Kanat Uygulaması  
Frame - Sash, cross - section  
Применение рама-створка  
تطبيق الإطار مع الضلقة

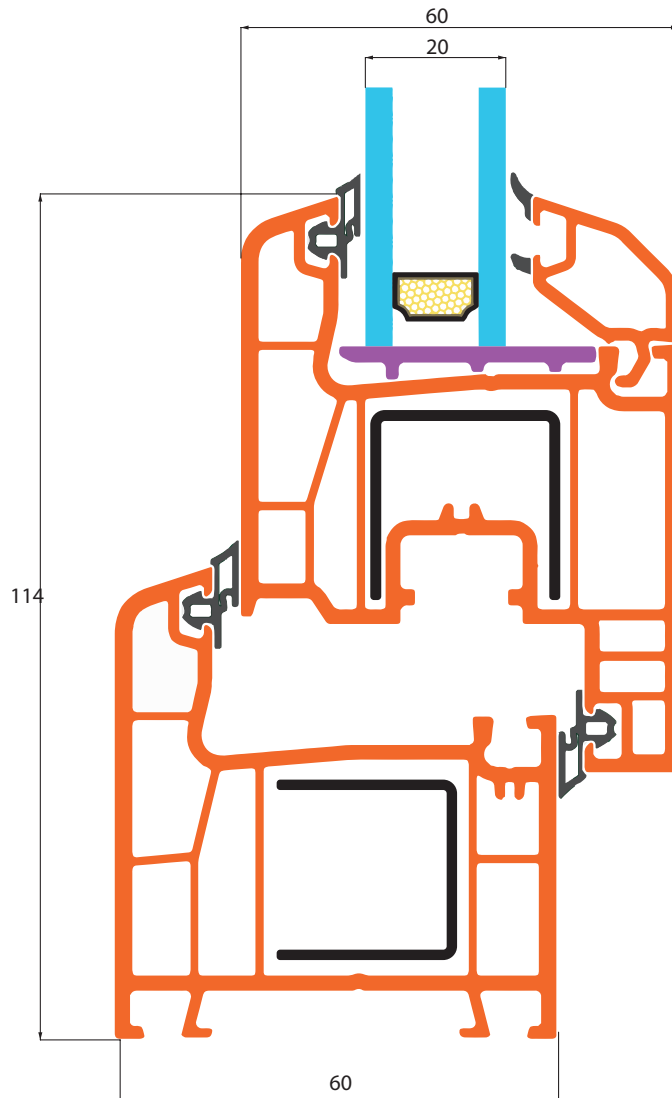
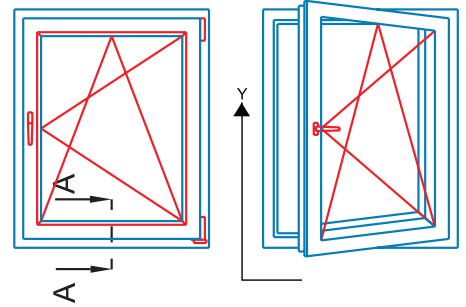

# BESSERHAUS

PVC DOOR AND WINDOWS SYSTEM

Kasa - İçe Açılım Kapı Kanadı Uygulaması

Frame In turn Door Sash, cross-section

Применение Рама-Дверная Створка Открытие Вовнутрь

تطبيق اللإطار مع ضلفة الباب الفتح إلى الداخل

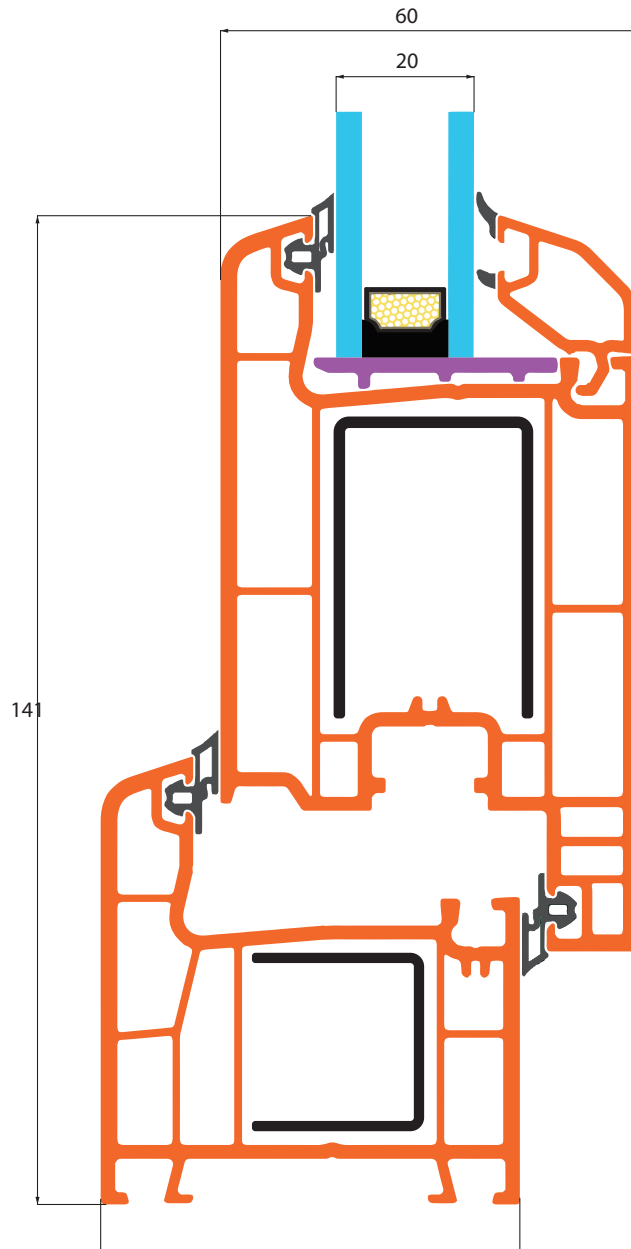
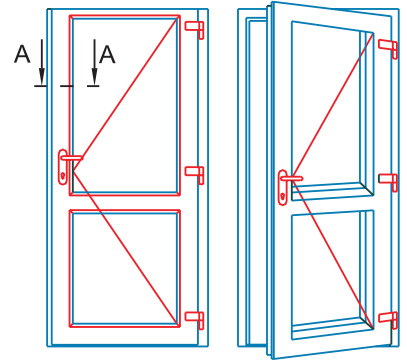

# BESSERHAUS

PVC DOOR AND WINDOWS SYSTEM

Kasa - Dışa Açılım Kapı Kanadı Uygulaması  
Frame - Out turn Door Sash, cross - section  
Применение рама- дверная створка открытие Наружу  
تطبيق الملائر مع ضلفة الباب الفتح إلى الخارج

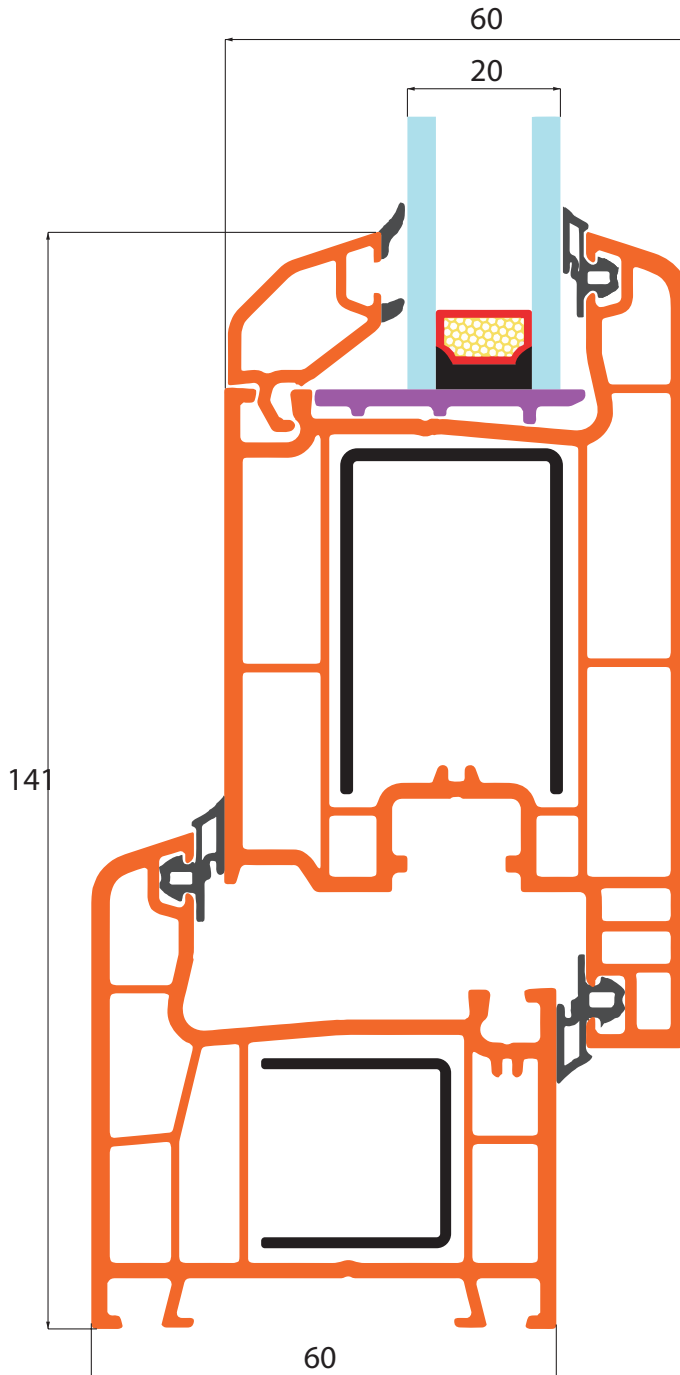
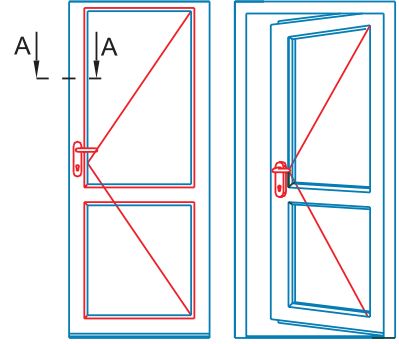

# BESSERHAUS

PVC DOOR AND WINDOWS SYSTEM

Pervazlı Kasa - Kanat Uygulaması  
Frame with Cornice Sash, cross-section  
Применение рама створка с откосом  
تطبيق الإطار بكشف مع الضلعة

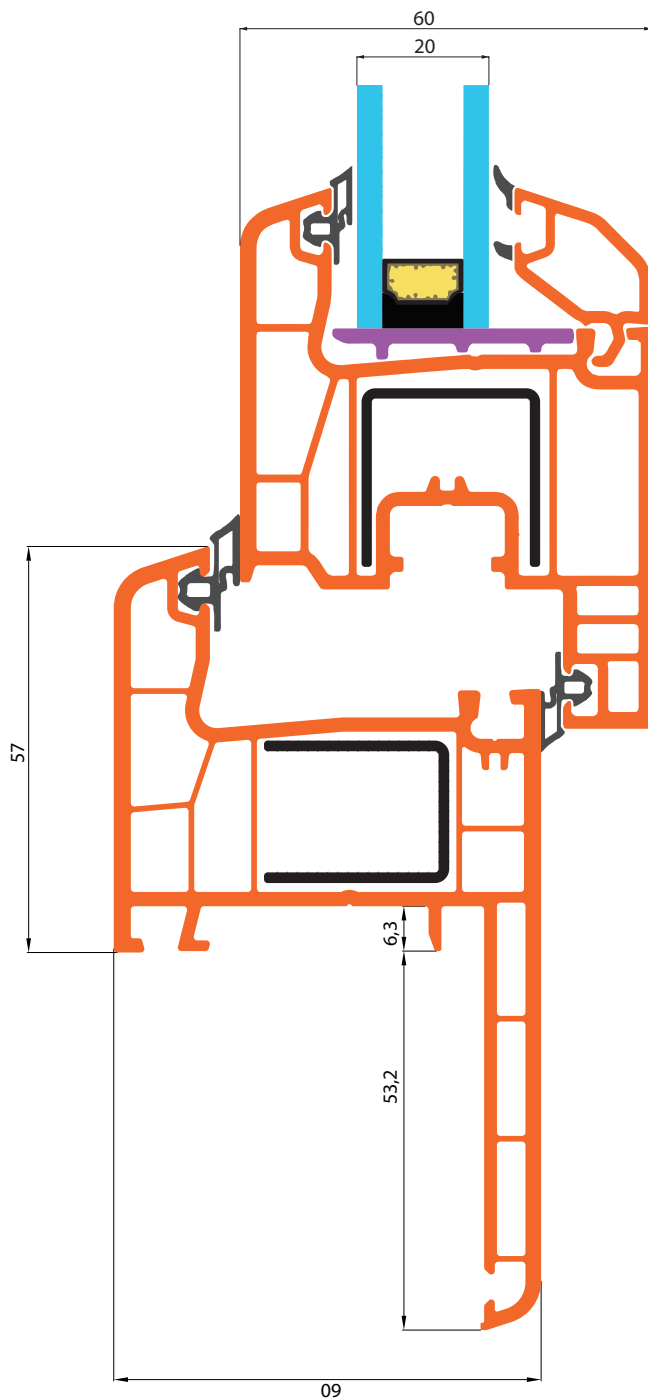
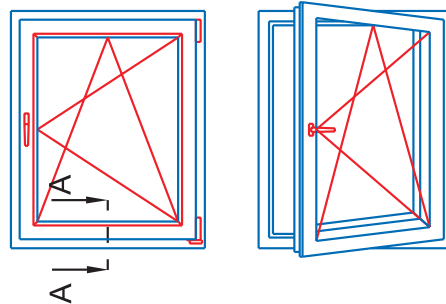

Pervazlı Kasa - Kanat Uygulaması  
Frame with Cornice Sash, cross-section  
Применение рама створка с откосом  
تطبيق الإطار بكشف مع الضلقة

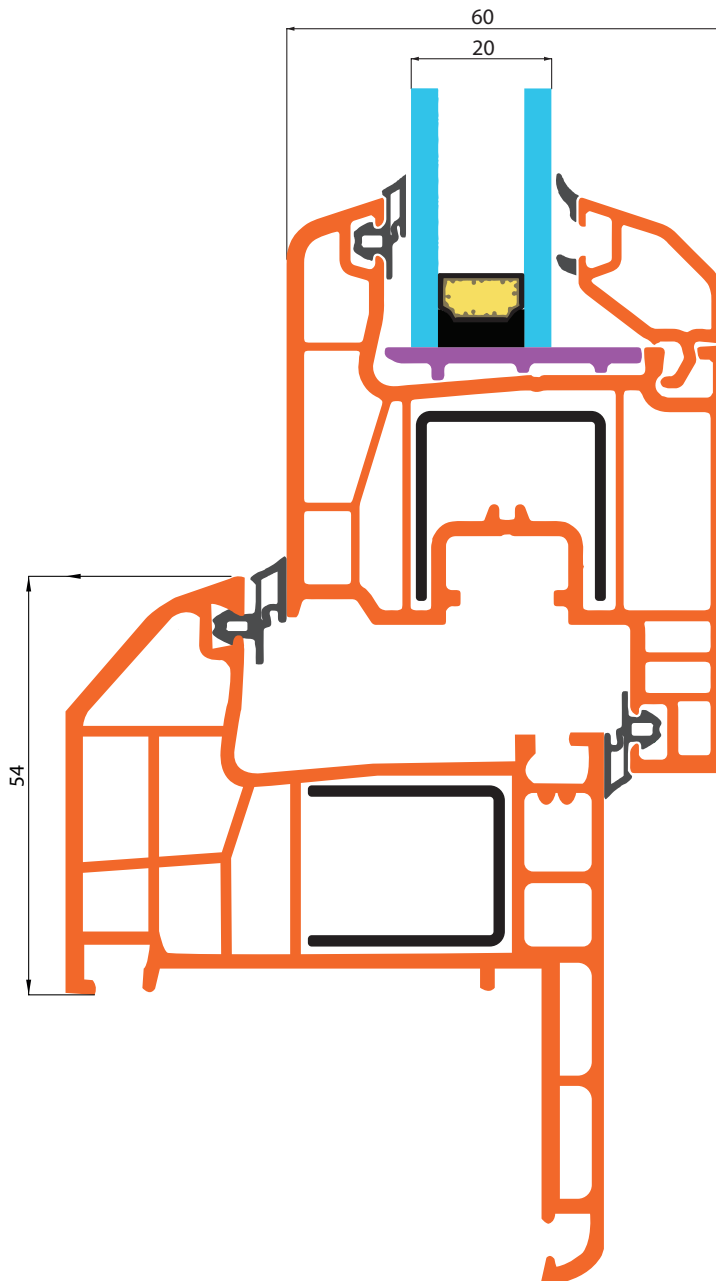
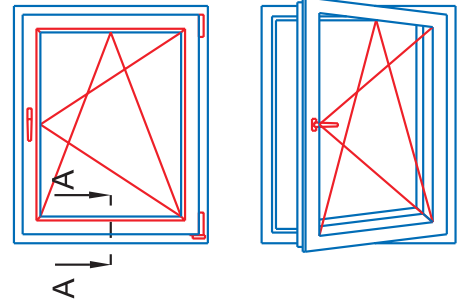

# BESSERHAUS

PVC DOOR AND WINDOWS SYSTEM

Kasa - Kanat Uygulaması  
Frame - Sash, cross - section  
Применение рама-створка  
تطبيق الإطار مع الضفافة

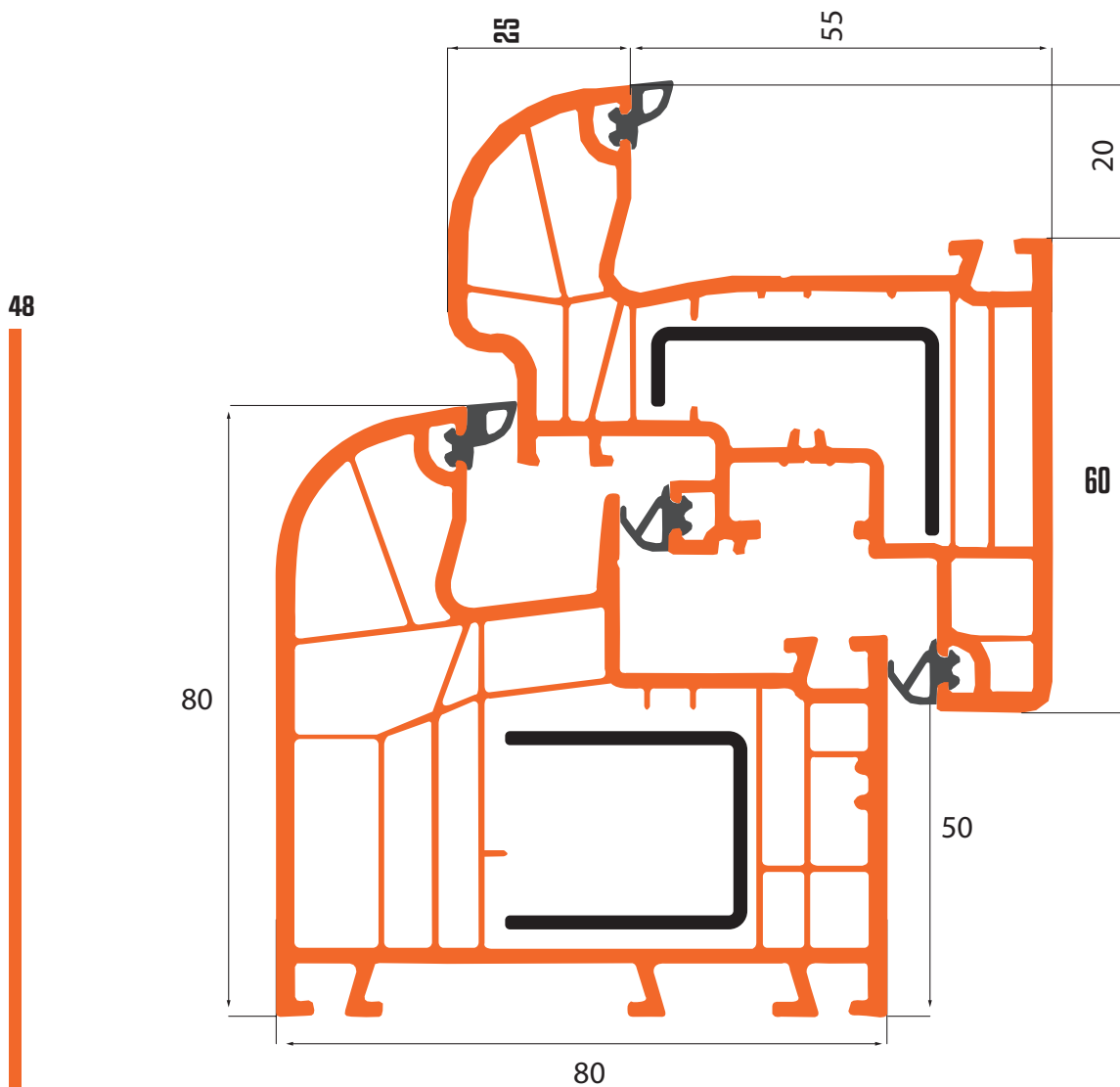
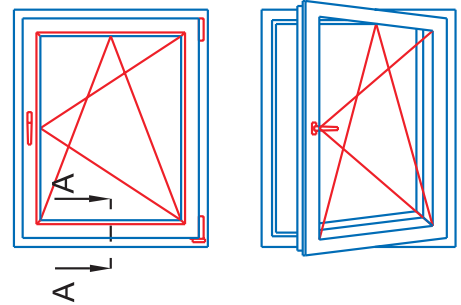



Kasa - İçe Açılım Kapı Kanadı Uygulaması  
Frame In turn Door Sash, cross-section  
Применение Рама-Дверная Створка Открытие Вовнутрь  
تطبيق اللإطار مع ضلفة الباب الفتح إلى الداخل

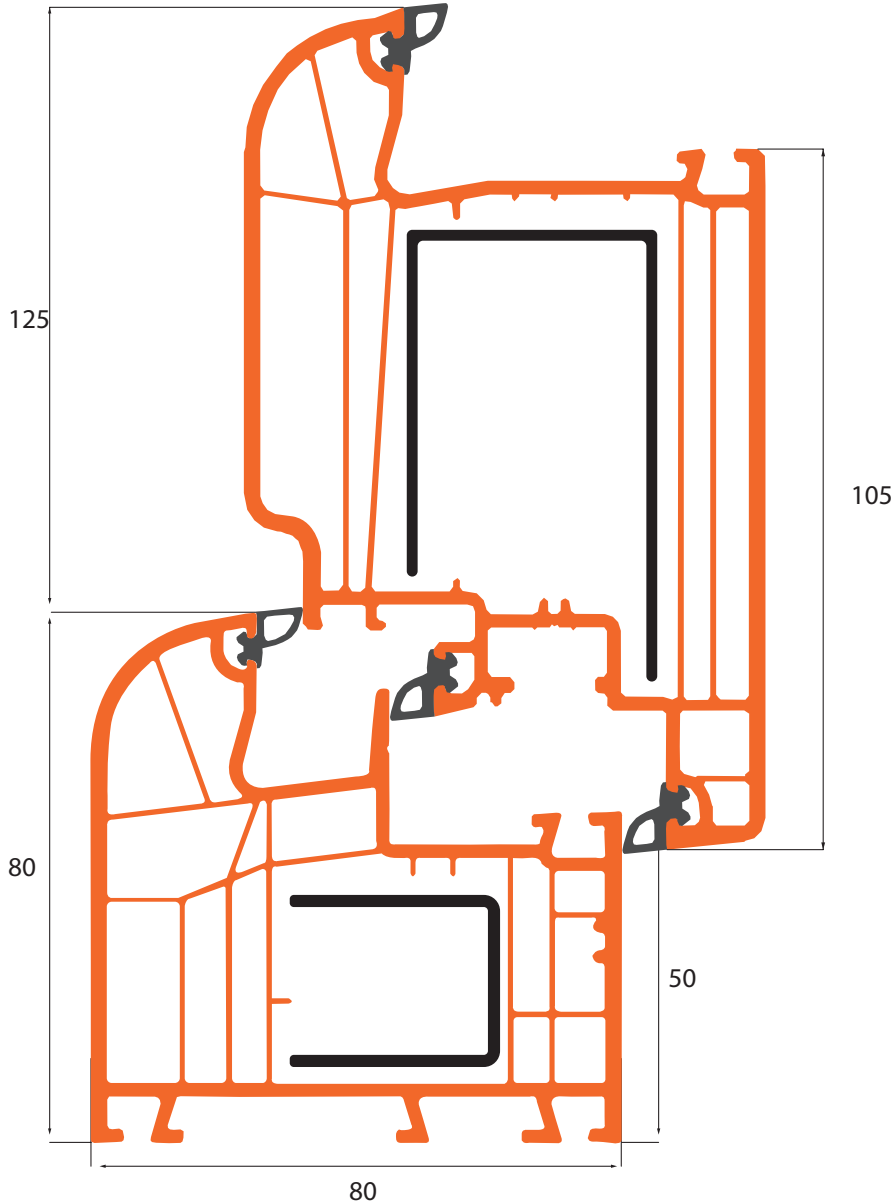
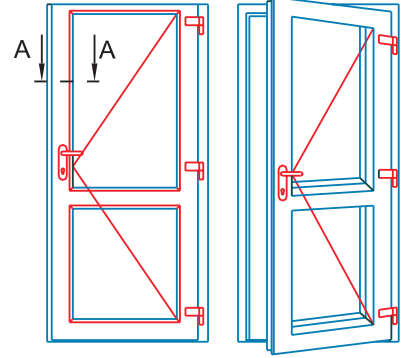

Ortakayıt Karađı  
Mullion Cover  
Заглушка импоста  
غطاء تي

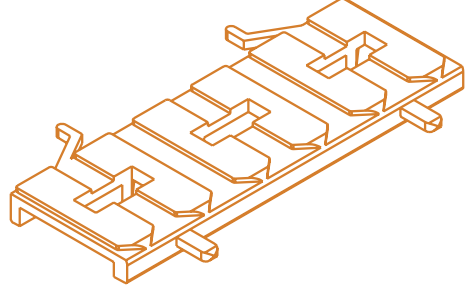
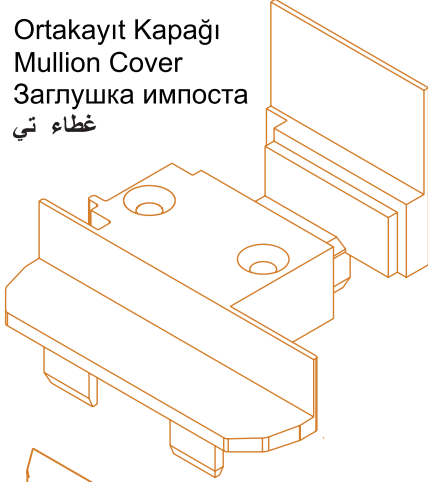

Cam Takožu  
Glass Wedge (Thick)  
Подкладка стеклопакета  
تسميكة الزجاج

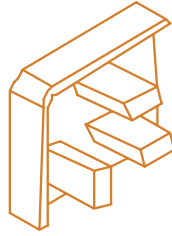

Damlalık Karađı  
Cover for drainage  
Крышка водоотлива  
غطاء مسيل المطر

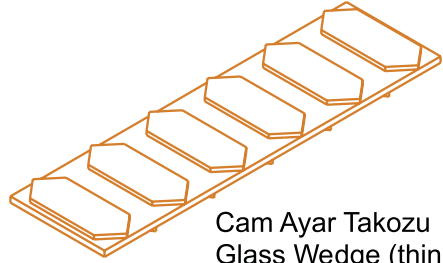

Cam Ayar Takožu  
Glass Wedge (thin)  
Подкладка регулировки  
стеклопакета  
تسميكة المعيار للزجاج

50

60x90 Pervaz Rozeti  
60x90 Cornice badge  
60x90 Соединитель  
профиля откоса  
وصلة تشبيك الكشيف ٦٠x٩٠



Su Tahliye Karađı  
Water Discharge Plug  
Крышка водостоков  
غطاء تفريغ الماء

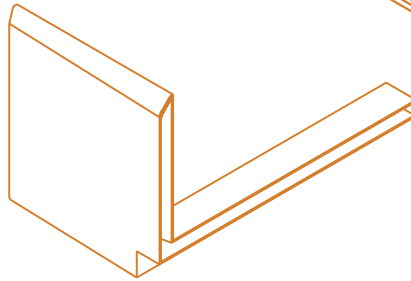

80x150 Pervaz Rozeti  
80x150 Cornice badge  
80x150 Соединитель  
профиля откоса  
وصلة تشبيك الكشيف ٨٠x١٥٠



Montaj Tapası  
Montage Plug  
Заглушка дюбеля  
غطاء التركيب

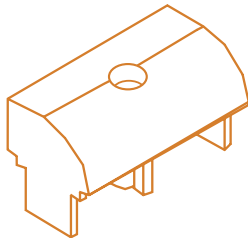

Kanat Kaldırma Takožu (Kanada Montaj)  
Lifting Wedge for Sash (Mounting to Sash)  
Фиксатор-балансир створки  
ترفيعة الضلفة (يركب على الضلفة)

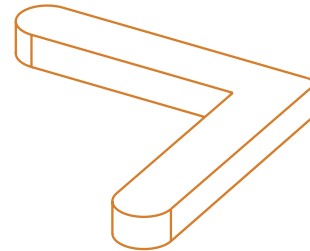

Köşe Birleřtirme Adaptörü (Pervaz)  
Corner Connect Piece for Cornice  
Адаптор углового соединения  
بروفيل أدبتر المعدل للزاوية (كرنيش)

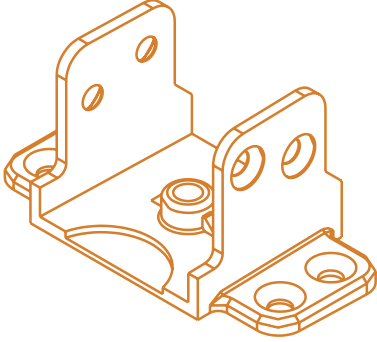

Ortakayıt Bağlantı Takozu  
Mullion Fitting Wedge  
Держатель импоста  
لقمة لربط بروفيل تي

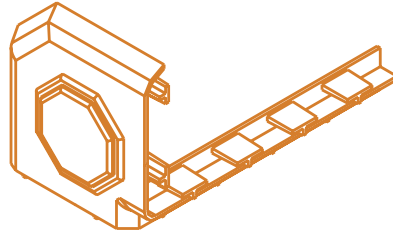

Pervaz Köşe Rozeti  
Corner cornice badge  
Соединитель профиля откоса  
وصلة تشبيك زاوية الكشكف

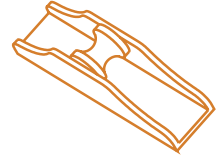

Sürme Sineklik Teker  
Sliding Fly Screen wheel  
Ролики для раздвижной  
москитной системы  
عجلة منخل السحاب

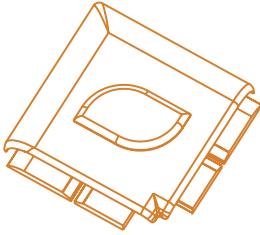

Universal Pervaz Rozeti  
Universal Cornice badge  
Универсальный соединитель  
профиля откоса  
وصلة كشكف اونى وارسال

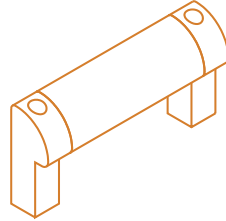

Sineklik Tutamağı  
Fly Screen holder  
Ручка для москитной  
сетки  
مسكة منخل

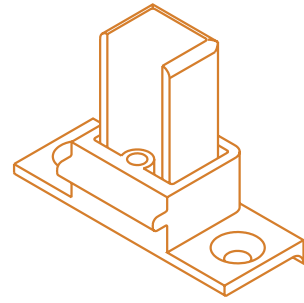

Sineklik Ortakayıt Takozu  
Fly Screen mullion wedge  
Держатель импоста для  
раздвижной москитной сетки  
لقمة تي المنخل

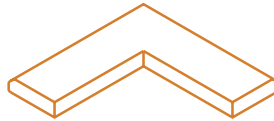

Universal Pervaz Klipsi  
Universal Cornice clip  
Универсальный адаптор  
углового соединения откоса  
زاوية كشكف اونى وارسال

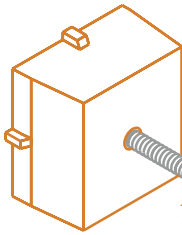

Köşe Mukavemet Takozu  
Corner Resistance Wedge  
Усилитель сварного угла  
كوم ٦٠٠ زاوية لحام

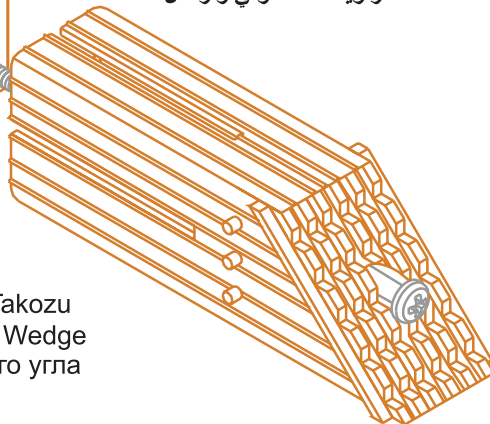

Sürme Sineklik Kasa Birleştirme  
Adaptörü  
Sliding Fly Screen Frame  
combination adaptor  
Соединительный профиль для  
раздвижной москитной системы  
ادبتر تشبيك سكة منخل السحاب

Yaytaş Mah. Organize Sanayi Bölgesi  
1. Etap 11. Sk. no: 12 Yenişehir /DİYARBAKIR

T : +90 412 252 55 36

F : +90 412 252 55 37

[info@greenwin.com.tr](mailto:info@greenwin.com.tr)

[www.greenwin.com.tr](http://www.greenwin.com.tr)

